

STILLA

ASSEMBLY INSTRUCTIONS



'Bromley' 6x12

Every part needed to construct your shed is included inside the pack; cedar panels, doors, windows, hardware kits & roof sheeting. Please ensure you fully unpack all the parts & check against the parts checklist before contacting customer service about anything you believe may be missing. Thank-you!

Caution

Please be careful when handling all components, some parts have sharp metal edges. Always wear work gloves, eye protection and long sleeves when assembling or maintaining your shed.

Tools required for assembly

- Level
- Drill (capable of driving 100mm Batten Screw)
- Hammer
- Ladder
- 10mm Drill bit
- 6mm Drill bit
- Tape measure
- Phillips head drive
- Hex Head Drive (5/16')
- Safety glasses
- Gloves
- Circular/power saw (if heavy duty floor was chosen)
- 4mm Alan key
- Batten screw drive

Before assembly

- Before proceeding with installation, we recommend viewing the Cedar Shed video at www.stilla.com.au/installation/ or search Stilla Classic Cedar Sheds on Youtube. This doesn't show the installation in detail however it could give you some handy tips. Please note we haven't videoed the assembly of each shed however the video online is the Maple 12x6 and will give you an overall idea on how the installation process is completed.
- Remove all parts from packages and place in a safe place close to assembly area.
- Review all instructions; continue to refer to instructions throughout assembly – step by step.

Preparing your site

- If you are installing your shed on the Stilla heavy duty floor, this can be placed on unlevelled surfaces and levelled up by using the 100x100 stumps provided.



BROMLEY 6x12 PARTS CHECKLIST

Part Code	Checked	Part Description	Qty
P		Cedar Clad Panel 900x1895mm	9
WP		Cedar Clad Window Panel 900x1895mm	1
WA		Cedar Shed Window Assembly (add per additional WP)	1
FP		Cedar Clad Front Panel 480x1895mm (remove if DD)	2
SCD		Single Colonial Door 830x1840mm (remove if DD)	1
G		6ft Gable	2
FP		Cedar Clad Front Panel 180x1895mm (DD option)	2
DCD		Double Colonial Door 714x1840mm (DD option)	2
CP		Corner Post 1890x60x20mm	4
CS		Cover Strip 1890x40x7mm	7
F		6ft Fascia Pack (4pcs) – 75x20mm block cedar	1
R		Roof Rafter 870x70x45mm	8
CT		Collar Tie	2
SDH		Single Door Head 840x70x45mm (remove if DD)	1
SDS		Single Door Step 840x42x19mm (remove if DD)	1
DDH		Double Door Head 1440x70x45mm (DD option)	1
DDS		Double Door Step 1440x42x19mm (DD option)	1
DP		Double Door Packer 100x100x20mm (DD option)	1
IWS		Internal Window Strip Set – 2@ 770mm, 2@ 735mm (add per additional WP)	1
E		Roof End Piece 203x70x30mm	12
RS		1120mm Roof Sheet	10
RS		1120mm Roof Sheet Single Pan	2
Sky		1120mm Skylight (option- swap with 1120 RS)	
RC		1520mm Ridge Cap	3
C		1307mm Channel	6
HK		6x12 Hardware Kit	1
IM		6x12 Instruction Manual	1
REP		Roof End Plate 1754x70x45mm	8
JP		Joining Plate 1112x70x45mm	4
RI		Roof Insulation 3600x1300mm (option)	2

Floor Kit – Option

Floor Frame - (140x35mm)

Part Code	Checked	Part Description	Qty
EP		End Plate 1884mm	4
DJ		Double Joist 1730mm	4
SJ		Single Joist 1730mm	6
L		Logs 750mm	6
FB		1798mm x 800mm	4
FB		1798mm x 311mm	1



If no floor option was purchased, go to step 2.0 (Wall Assembly)

SKIP TO BACK FOR IMAGES TO HELP WITH FLOOR INSTALL

STEP 1.0

FLOOR KIT

1.0 – FLOOR KIT (1 of 2 floor frames)		
PART CODE	QTY	DESCRIPTION
EP	2	End Plate 1884mm
SJ	3	Single Joist 1730mm
DJ	2	Double Joist 1730mm
100BS	24	100mm Batten Screw

1.0 – FLOOR FRAME (1 of 2 floor frames)

Fasten floor frame together as indicated in diagram below, using lines and predrilled holes. Screw through EP into DJ using 3x 100BS. Screw through EP into SJ using 2 x 100BS per join. Ensure frame is square by measuring from corner to corner diagonally, frame will be square when both diagonal measurements equal the same.

REPEAT THIS PROCESS FOR FASTENING 1 MORE FLOOR FRAME.

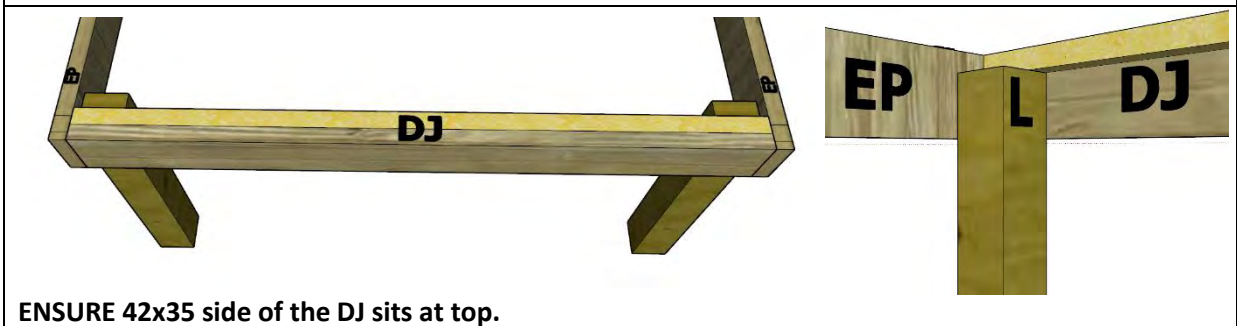
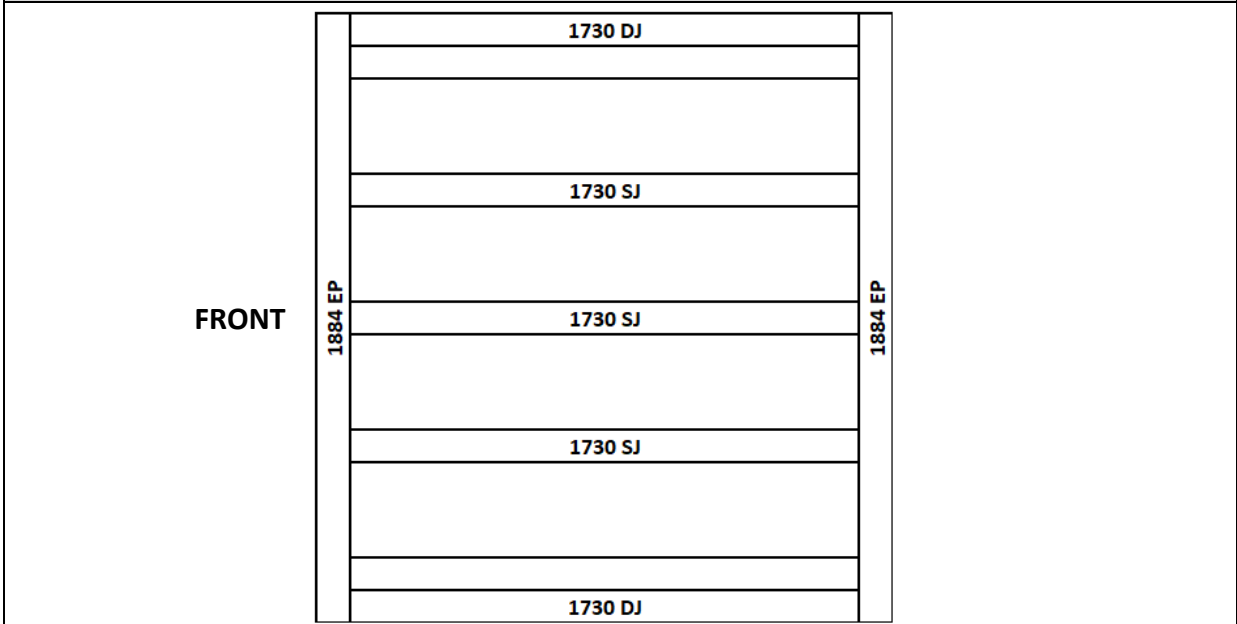

ENSURE 42x35 side of the DJ sits at top.



STEP 1.1

FLOOR FRAME INSTALLATION

The 6x12 floor frame comes in two parts. Install first floor frame in desired position at desired height and fasten to logs once level and square, then join and fasten next frame and repeat.

1.1 – FLOOR FRAME INSTALLATION		
PART CODE	QTY	DESCRIPTION
L	6	Logs 750x100x100mm
100BS	24	100mm batten screws
65BS	8	65mm Batten Screws
200PB	6	200mm M12 Post Bolt
W	12	M12 Washers

1.1 – FLOOR FRAME INSTALLATION

Repeat the steps below for each floor frame, joining the floor frames together as you go in order displayed in diagram below.

1. Lay out frame in desired position and mark holes to dig, as indicated on diagram below (use shovel or marking paint).
2. Dig and place logs in holes (using concrete if you wish).
3. Fasten floor frame to logs at desired height, using 4x 100BS per log, ensuring frame is level*.
4. Butt next floor frame into installed frame and join using 8x 65BS evenly spaced along the EP.
5. Repeat process until all frames are joined.

** Fasten frame to logs when roughly level and then critique by hammering in or adding dirt (or concrete) to corners until perfectly level at every post.*

Once all frames are joined, predrill holes (using a 13mm drill bit) and bolt each log to the floor frame in spots indicated with 200PB, using washers on both sides.

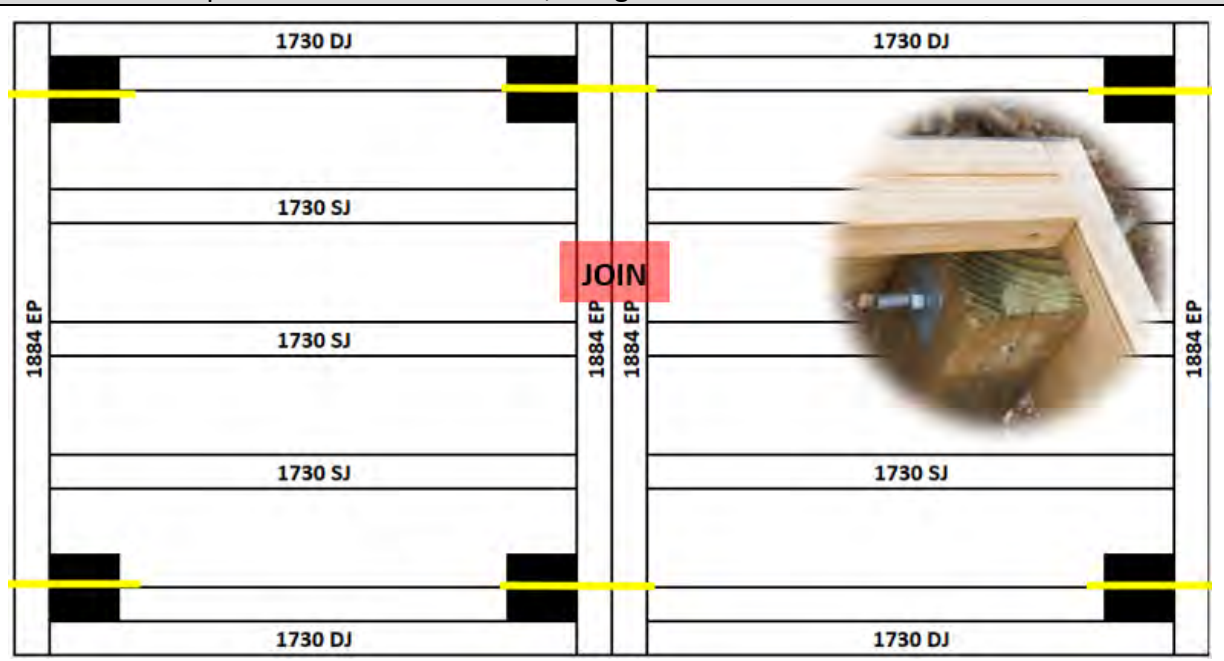

STEP 1.2

FLOOR INSTALLATION

1.2 – FLOORING INSTALLATION		
PART CODE	QTY	DESCRIPTION
FB	4	Floor Board 1798x800mm
FB	1	Floor Board 1798x311mm
50PS	75	50mm Philips Screw

1.2– FLOORING INSTALLATION
 Fasten floor sheets to floor frame as shown in diagram below using 50PS.
 Bring Floor sheets in **43mm** on all 4 sides from the outside of the floor frame.
Note- The x marked on the floor sheets do not line up with out joists.

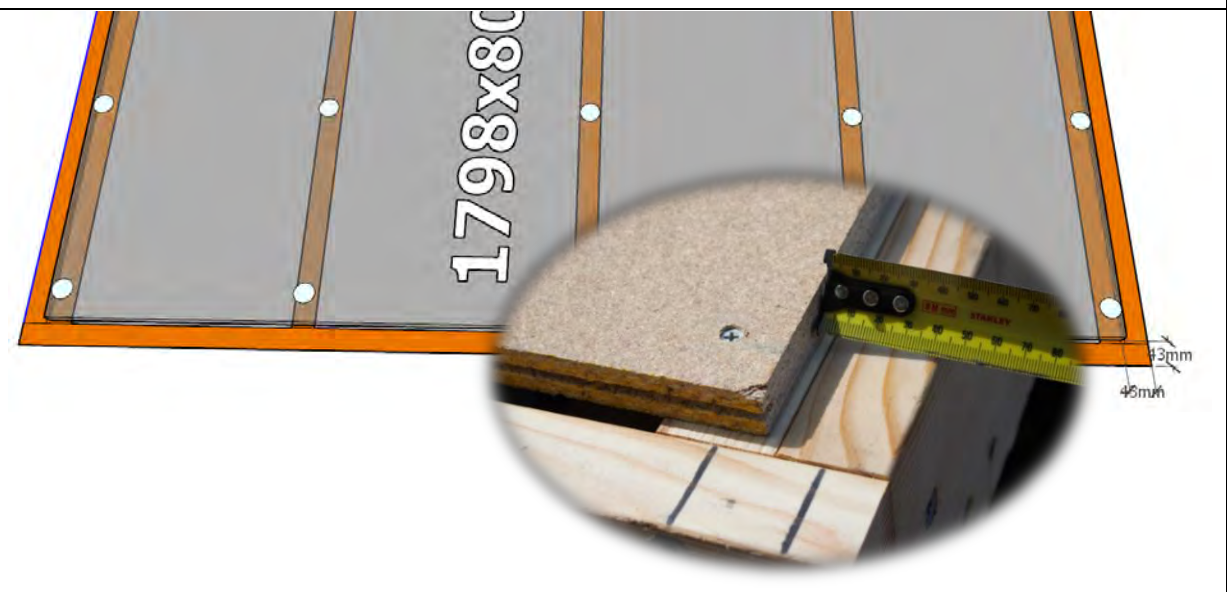
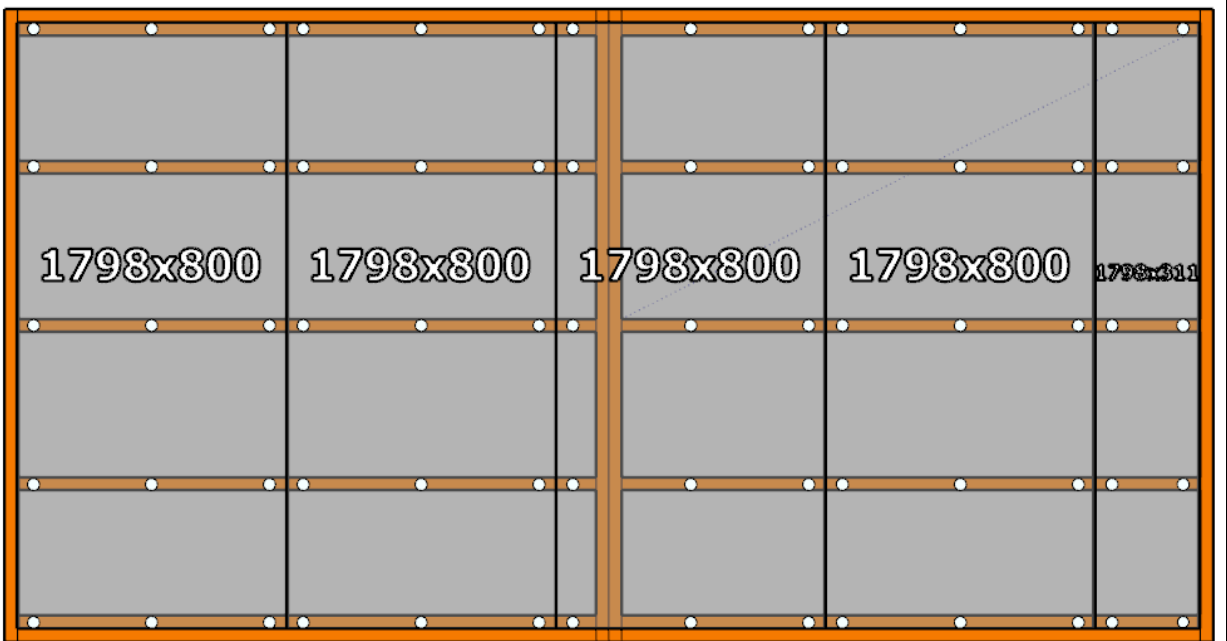

STEP 2.0

WALL ASSEMBLY

WALL PANEL (WP) (900MM WINDOW PANEL) CAN BE POSITIONED ANYWHERE ON THE SHED WHERE WE HAVE USED A (P) (900MM WALL PANEL).

2.0 - ASSEMBLY PARTS – WALL ASSEMBLY		
PART CODE	QTY	DESCRIPTION
FP	1	Front wall panel
P	1	900mm Wall panel
65HHS	3	65mm Hex head screw

2.0 - ASSEMBLY – WALL ASSEMBLY

Screw through FP into P (top, centre & bottom) using 3 x 65HHS. (Holding studs flush on the outside). Ensure Cedar Strip is on door side. **Note: Ensure tongue on cedar cladding is at top.**

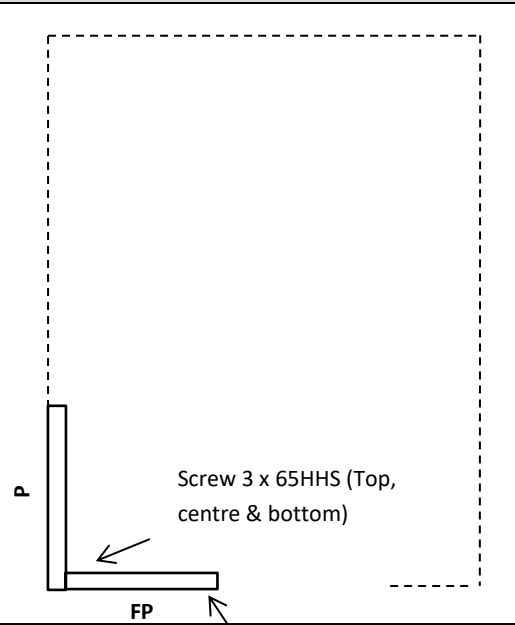

When screwing the four corners together please make sure the studs are flush on the outside (not the inside) as per image below.



STEP 2.1

WALL ASSEMBLY

2.1 - ASSEMBLY PARTS – WALL ASSEMBLY

PART CODE	QTY	DESCRIPTION
P	1	900mm Wall panel
65HHS	3	65mm Hex head screw

2.1 - ASSEMBLY PARTS – WALL ASSEMBLY

Screw through P into P (Top, centre & bottom) using 3 x 65HHS, holding studs flush on the inside.

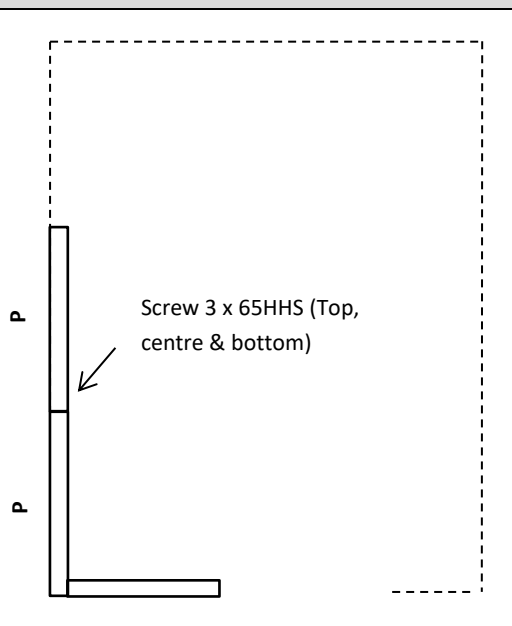

STEP 2.2

WALL ASSEMBLY

2.2 - ASSEMBLY PARTS – WALL ASSEMBLY

PART CODE	QTY	DESCRIPTION
P	1	900mm Wall panel
65HHS	3	65mm Hex head screw

2.2 - ASSEMBLY PARTS – WALL ASSEMBLY

Screw through P into P (Top, centre & bottom) using 3 x 65HHS, holding studs flush on the **inside** – Repeat with last panel

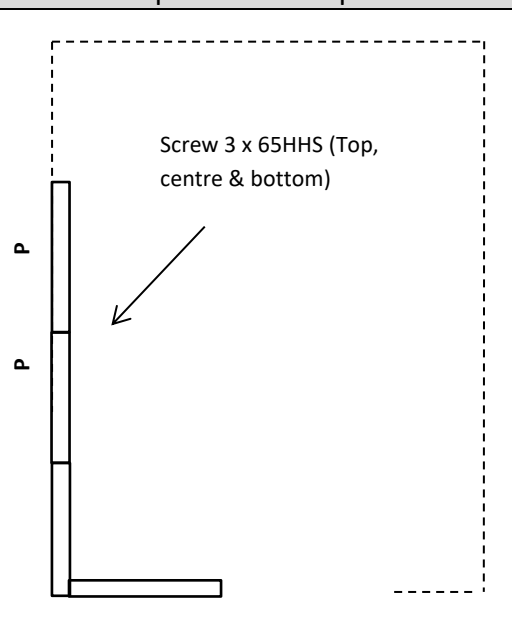

STEP 2.3

WALL ASSEMBLY

2.3 - ASSEMBLY PARTS – WALL ASSEMBLY

PART CODE	QTY	DESCRIPTION
P	1	900mm Wall panel
65HHS	3	65mm Hex head screw

2.3 - ASSEMBLY PARTS – WALL ASSEMBLY

Screw through P into P (Top, centre & bottom) using 3 x 65HHS, holding studs flush on the outside.

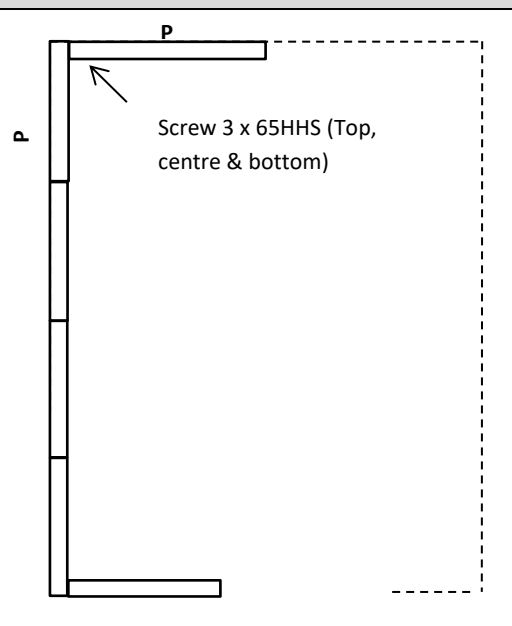

STEP 2.4

WALL ASSEMBLY

2.4 - ASSEMBLY PARTS – WALL ASSEMBLY

PART CODE	QTY	DESCRIPTION
P	1	900mm Wall panel
65HHS	3	65mm Hex head screw

2.4 - ASSEMBLY PARTS – WALL ASSEMBLY

Screw through P into P (top, centre & bottom) using 3 x 65HHS holding studs flush on the inside.

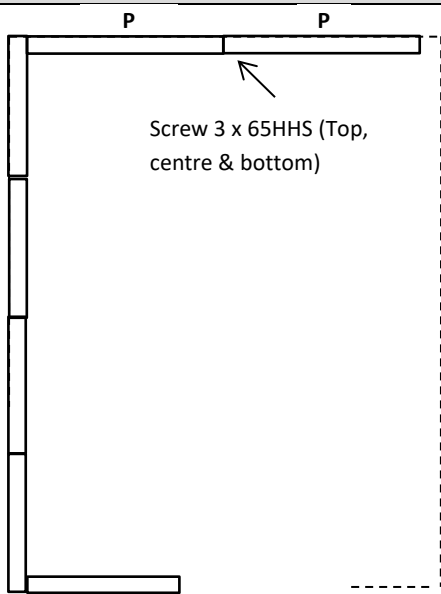

STEP 2.5

WALL ASSEMBLY

2.5 - ASSEMBLY PARTS – WALL ASSEMBLY		
PART CODE	QTY	DESCRIPTION
P	1	900mm Wall panel
65HHS	3	65mm Hex head screw

2.5 - ASSEMBLY PARTS – WALL ASSEMBLY
 Screw through P into P (top, centre & bottom) using 3 x 65HHS holding studs flush on the outside.

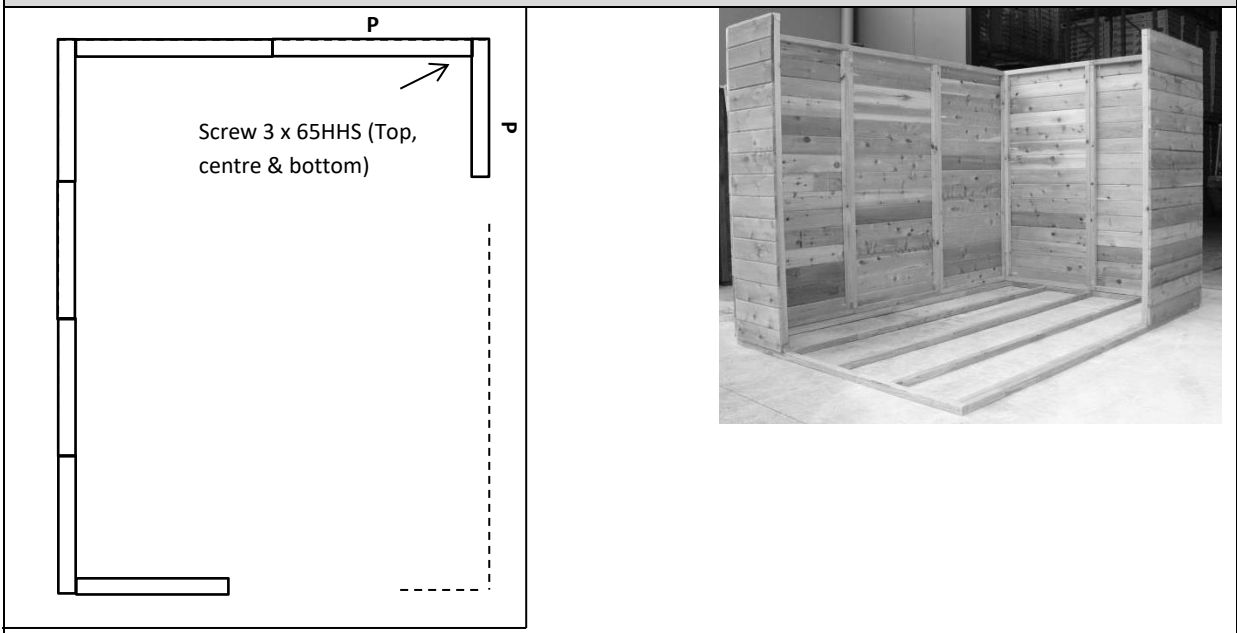

STEP 2.6

WALL ASSEMBLY

2.6 - ASSEMBLY PARTS – WALL ASSEMBLY

PART CODE	QTY	DESCRIPTION
WP	1	900mm Window panel
65HHS	3	65mm Hex head screw

2.6 - ASSEMBLY PARTS – WALL ASSEMBLY

Screw through WP into P (top, centre & bottom) using 3 x 65HHS holding studs flush on the **inside**.

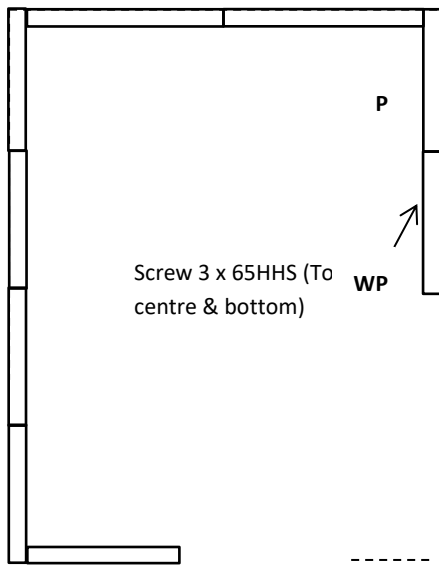

STEP 2.7

WALL ASSEMBLY

2.7 - ASSEMBLY PARTS – WALL ASSEMBLY		
PART CODE	QTY	DESCRIPTION
P	1	900mm Wall panel
65HHS	3	65mm Hex head screw

2.7 - ASSEMBLY PARTS – WALL ASSEMBLY

Screw through P into WP (top, centre & bottom) using 3 x 65HHS holding studs flush on the **inside**. Repeat with final panel

WP

P

Screw 3 x 65HHS (Top, centre & bottom)



STEP 2.8

WALL ASSEMBLY

2.8 - ASSEMBLY PARTS – WALL ASSEMBLY

PART CODE	QTY	DESCRIPTION
FP	1	Front wall panel
65HHS	3	65mm Hex head screw

2.8 - ASSEMBLY PARTS – WALL ASSEMBLY

Screw through FP into P (top, centre & bottom) using 3 x 65HHS holding studs flush on the **outside**. Ensure Cedar Strip is on door side.

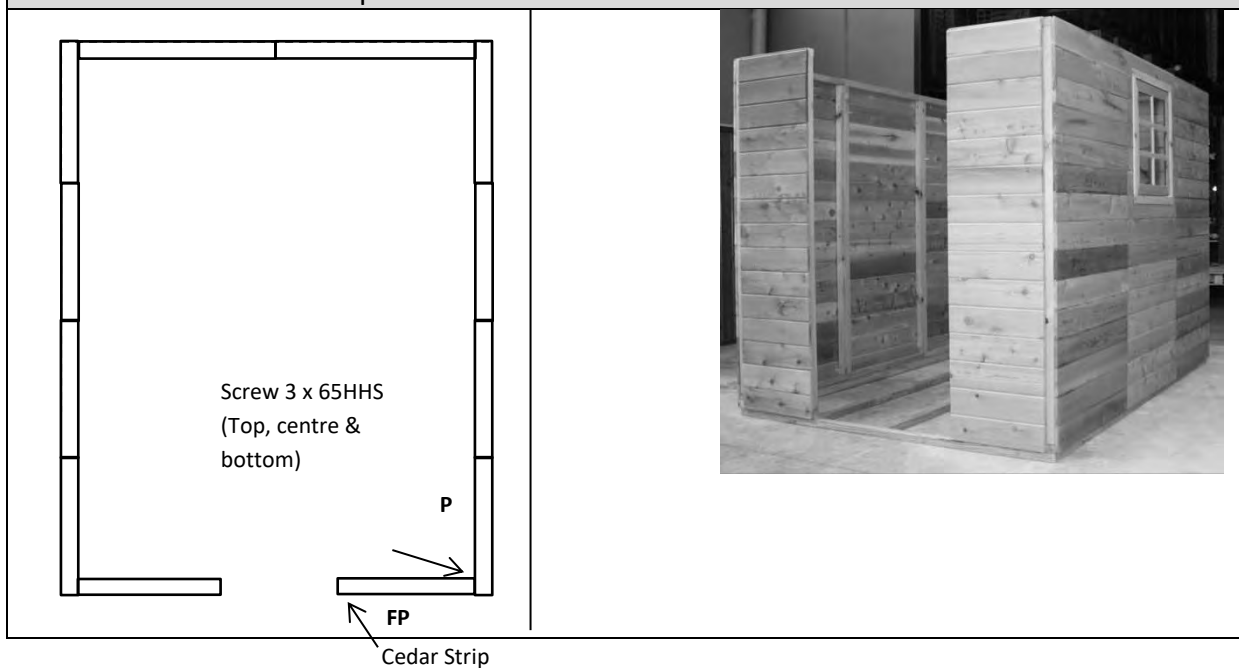

STEP 2.9

DOOR STEP INSTALL

2.9 - ASSEMBLY PARTS – DOOR STEP INSTALL		
PART CODE	QTY	DESCRIPTION
SDS	1	840x42x19mm Single Door Step (Replace with 1440 DS if DD)
DDS	1	1440x42x19mm Double Door Step (ONLY FOR DD OPTION)
40N	4	40mm Nail

2.9 - ASSEMBLY – DOOR STEP INSTALL

Nail Door Step in position using 4x 40N* as seen below. Ensure wall panels are tight against DS.

** This is if floor option was chosen. If you are installing on concrete slab, use concrete nails or small dyno bolts to fasten (not provided).*

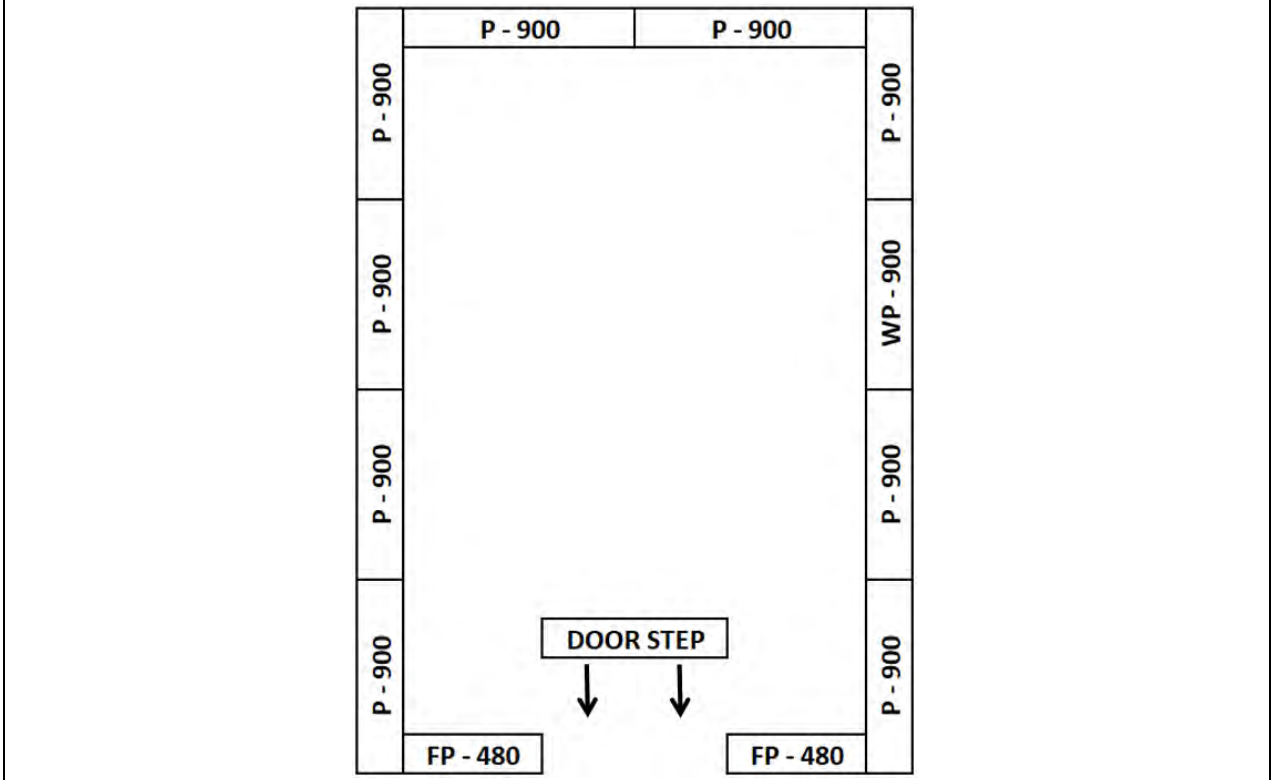

STEP 3.0

DOOR HEAD ASSEMBLY

3.0 - ASSEMBLY PARTS – DOOR HEAD ASSEMBLY		
PART CODE	QTY	DESCRIPTION
SDH	1	840x70x45mm Single Door Head (replace with 1440mm DH if DD)
DDH	1	1440x70x45mm Double Door Head (ONLY FOR DD OPTION)
65HHS	2	65mm Hex head screw

3.0 - ASSEMBLY – DOOR HEAD ASSEMBLY
 Hold SDH (or DDH) flush with top of panels. Ensure top cedar tongue on door head at front lines up with top cedar tongue of Front panel. Screw through FP into SDH using 1x 65HHS per side.

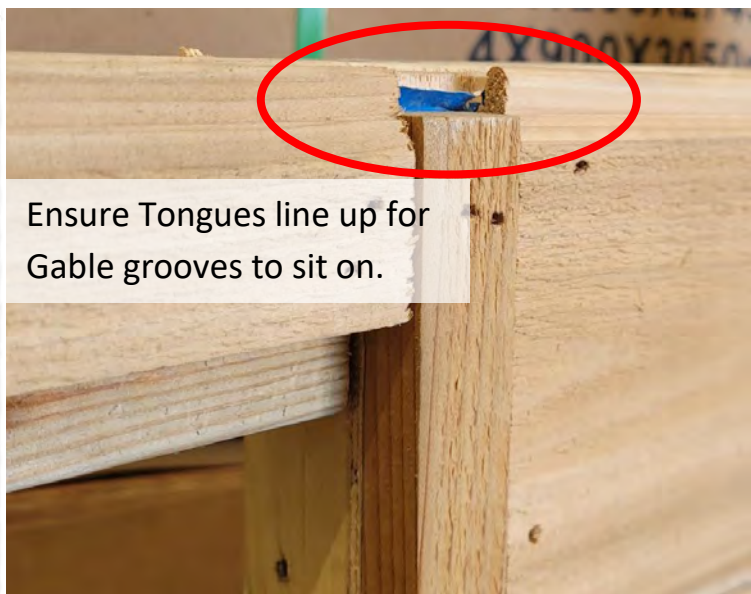
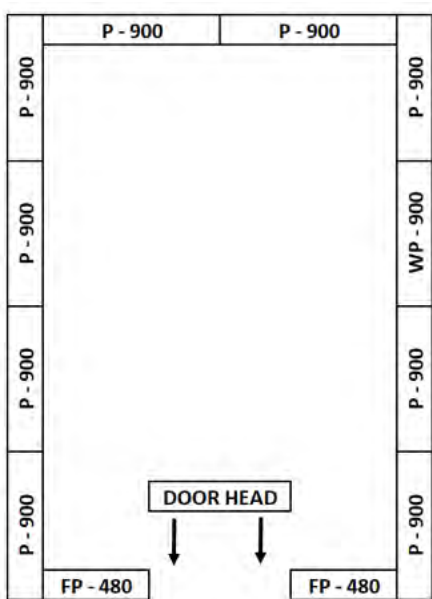

STEP 3.1

GABLE INSTALL

3.1 - ASSEMBLY PARTS – GABLE INSTALL

PART CODE	QTY	DESCRIPTION
G	2	6ft Gable
65HHS	10	65mm Hex head screw

3.1 - ASSEMBLY – BACK GABLE INSTALL

Carefully position Gable in place, carefully inserting gable groove onto tongue on back panels. Screw 3x 65HHS through panels up into ends and centre of bottom plate of gable.



Screw 3x 65HHS up into either end and centre of gable.

3.1 - ASSEMBLY – FRONT GABLE INSTALL

Carefully position Gable in place, carefully inserting gable groove onto tongues on front panels and door head. Screw 2x 65HHS through both front panels up into ends of bottom plate of gable. Screw 3x 65HHS through gable bottom plate, down into door head.



Screw 2x 65HHS through either front panel up into gable.



Screw 3x 65HHS down through gable into door head.



STEP 4.0

ROOF FRAME ASSEMBLY

4.0 - ASSEMBLY PARTS – ROOF ASSEMBLY (REPEAT TWICE)		
PART CODE	QTY	DESCRIPTION
REP	4	Roof End Plate 1754x70x45mm
R	4	Roof Rafter 870x70x45mm
JP	2	Joining Plate 1112x70x45mm
75BS	40	75mm Batten Screw

4.0 - ASSEMBLY – ROOF ASSEMBLY (1 of 2 frames)
 It helps to find a flat, level surface to complete this process on.

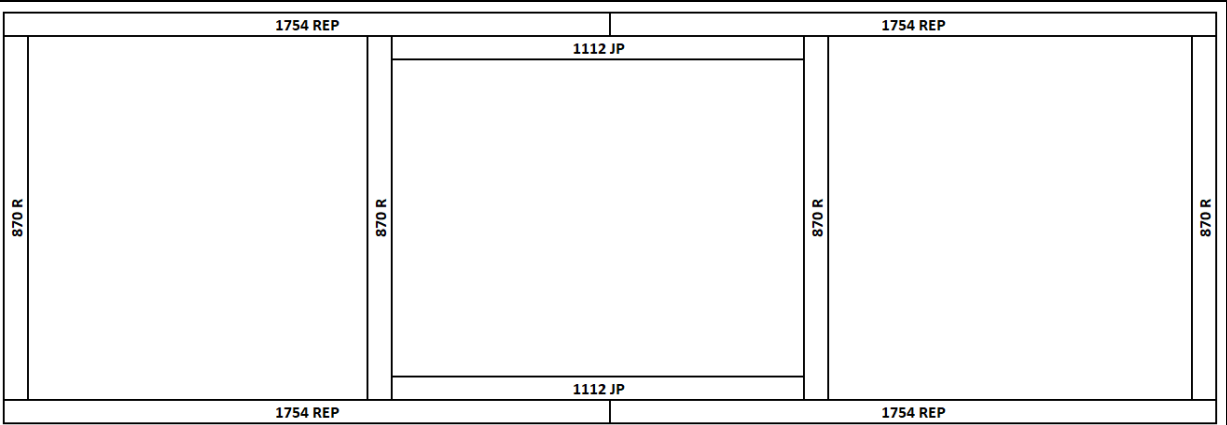

1. Position JP up to the 556mm line on REPs, hold flush and use predrilled holes to screw two Roof End Plates (REP) together with Joining Plate (JP) using 75BS (as pictured).
Repeat this twice.



2. Place 4x Roof Rafters (R) in between joined REPs as seen in diagram above and screw 75BS into predrilled holes to finish assembling one roof frame.

REPEAT THIS ASSEMBLY PROCESS TWICE TO COMPLETE BOTH ROOF FRAMES – ENSURE FRAMES ARE SQUARED BEFORE MOVING ON



STEP 4.1

ROOF INSULATION INSTALL

If you did not purchase this option please skip this step

4.1 - ASSEMBLY PARTS – ROOF INSULATION INSTALL (REPEAT TWICE)

PART CODE	QTY	DESCRIPTION
RI (option)	1	Roof Insulation 3600x1300mm
40N	30	40mm Nail

4.1 - ASSEMBLY – ROOF INSULATION INSTALL (REPEAT WITH SECOND FRAME)

It helps to find a flat, level surface to complete this process on.

Once roof frame is assembled, fix Roof Insulation to top of frame before screwing roof sheets over top.

Fix Roof Insulation to top of frame using bent 40N (or staples- not supplied).

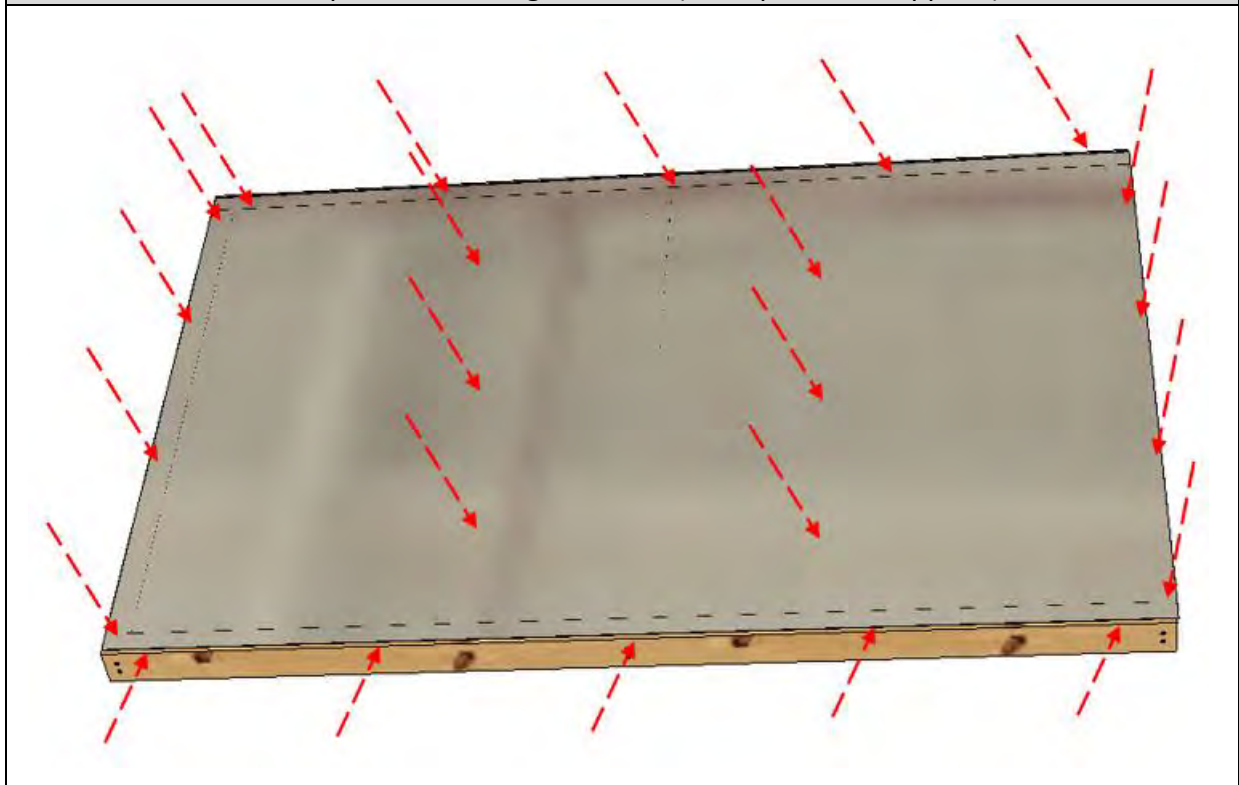

STEP 4.2

ROOF ASSEMBLY

4.2 - ASSEMBLY PARTS – ROOF ASSEMBLY (ROOF SHEETS)		
PART CODE	QTY	DESCRIPTION
RS	2	1120mm roof sheet
40RS	2	40mm Roof screw
25RS	2	25mm Roof screw

4.2 - ASSEMBLY – ROOF ASSEMBLY (ROOF SHEETS)

It helps to find a flat, level surface to complete this process on.

Position roof sheets (RS) at either end of roof frame and fasten in place as indicated in diagrams. Lay roof sheet (bent edge) flush with top of roof frame while hanging side of roof sheet **203mm*** over end of roof frame. Once in position, screw 25RS through pan at top** FIRST and then (checking bottom is still overhanging 203mm from side) screw a 40RS through rib at the bottom** to fasten roof sheet in place.

** Use 203mm “E” or tape measure when placing overhanging side of roof sheet (ENSURE ROOF SHEET RUNS PARRELEL TO ROOF FRAME END).*

*** Only screw 25RS in pan at the top and 40RS in the bottom of roof sheet.*

Hang side of roof sheet, 203MM over end of roof frame (TOP)

Bent up edge at top

(SIDE VIEW)

(END VIEW)

REPEAT THIS STEP FOR SECOND ROOF FRAME



STEP 4.3

ROOF ASSEMBLY

4.3 - ASSEMBLY PARTS – ROOF ASSEMBLY (ROOF SHEETS)		
PART CODE	QTY	DESCRIPTION
RS	3	1120mm roof sheet
RS	1	1120mm single pan roof sheet
40RS	5	40mm Roof screw
25RS	10	25mm Roof screw

4.3 - ASSEMBLY – ROOF ASSEMBLY (ROOF SHEETS)
 Complete laying roof sheeting out on frame. Fasten roof sheets to battens in sequence shown. 1 x 25RS either side of join at top and 1 x 40RS through rib join at bottom.
Note: Use straight edge to keep all screws in line and centre of batten.

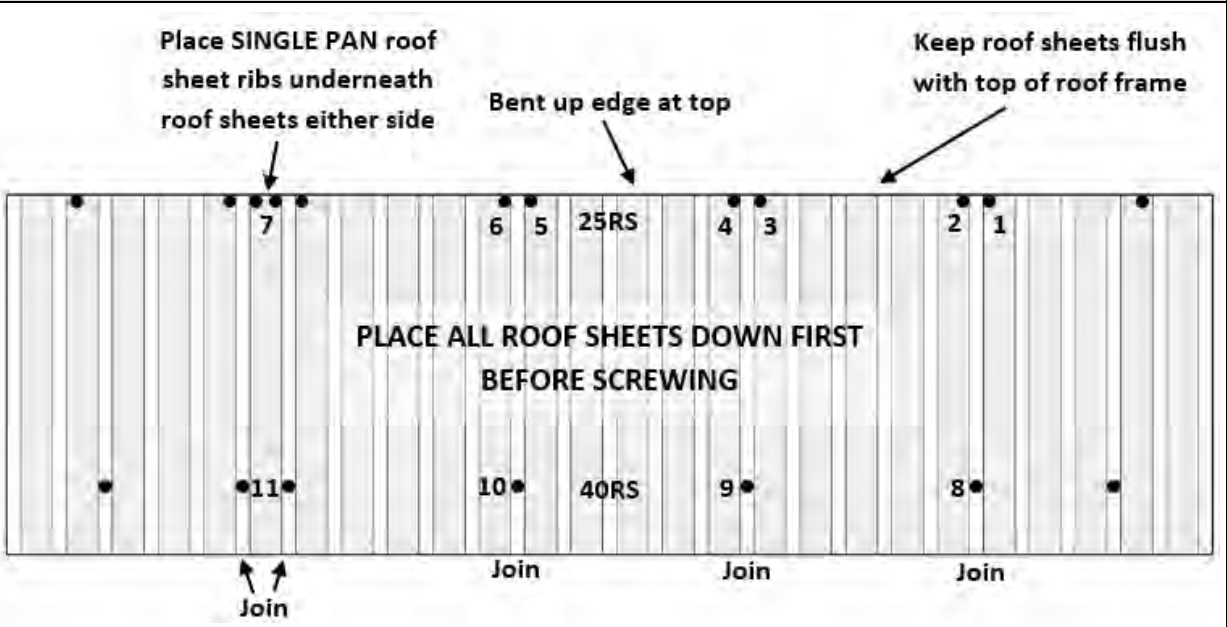

REPEAT THIS STEP FOR SECOND ROOF FRAME



STEP 4.4

ROOF ASSEMBLY

4.4 - ASSEMBLY PARTS – ROOF ASSEMBLY

PART CODE	QTY	DESCRIPTION
40RS	18	40mm Roof screw
25RS	16	25mm Roof screw

4.4 - ASSEMBLY – ROOF ASSEMBLY

Complete screwing roof off at top. 1 x 25RS in pan beside every rib. Once top is complete screw bottom off using 1 x 40RS through every rib.

Note: Use straight edge to keep all screws in line and centre of batten.

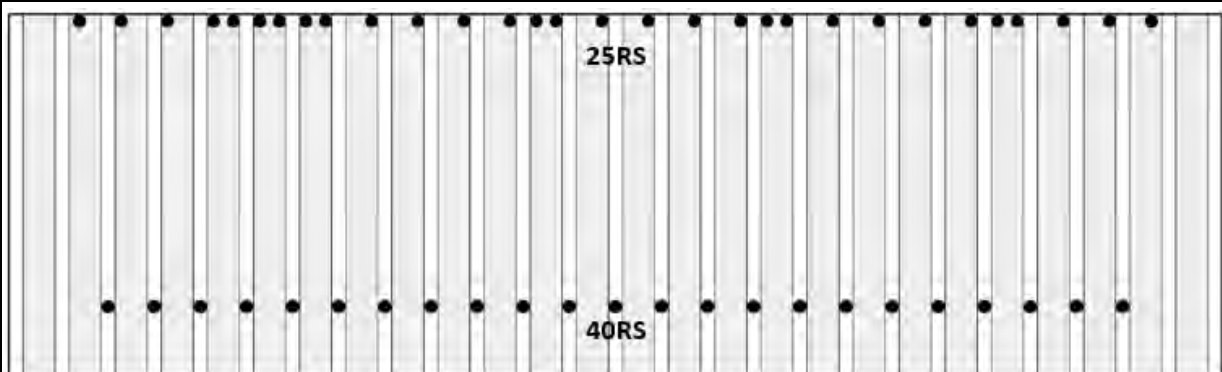

REPEAT THIS STEP FOR SECOND ROOF FRAME



STEP 4.5

CHANNEL ASSEMBLY

If you purchased the Annex, leave the channel off the side you will be installing your Annex

4.5 - ASSEMBLY PARTS – CHANNEL ASSEMBLY		
PART CODE	QTY	DESCRIPTION
ST	9	12mm self-tapping screw
C	3	1307mm Roof Channel

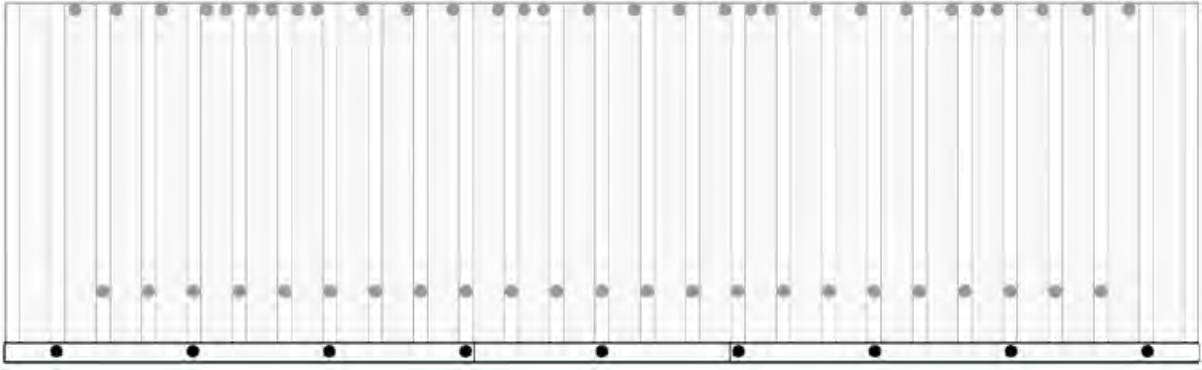
4.5 - ASSEMBLY – CHANNEL ASSEMBLY		
Slide Roof channel onto end of roof sheeting overhang. Fasten in place using ST.		
(TOP)		
		
1120 RS		
REP	870 R	REP

REPEAT TASKS 4.0 – 4.5 TO COMPLETE THE OTHER ROOF PANEL.

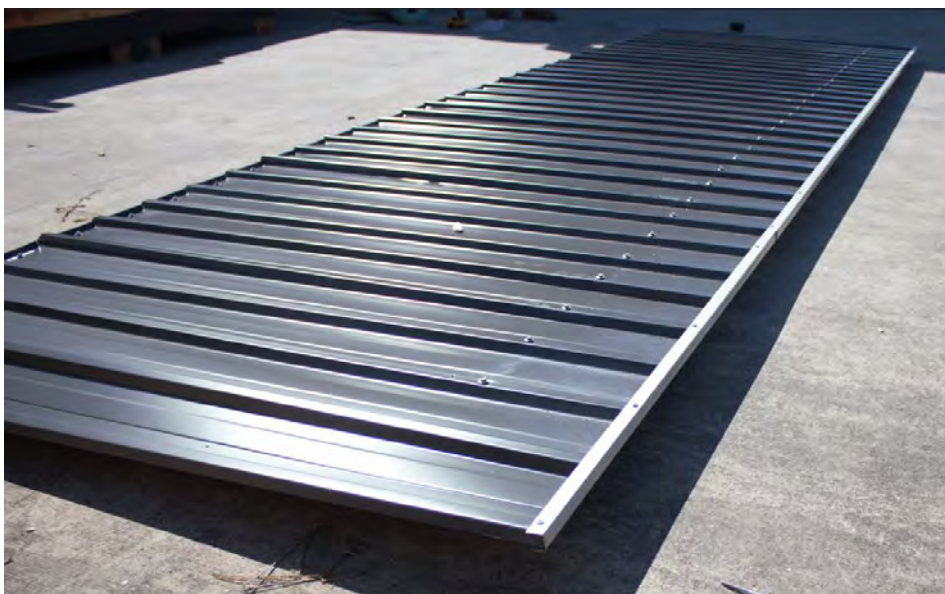

STEP 4.6

ROOF END PIECE

4.6 - ASSEMBLY PARTS – RIDGE BEAM BRACKET

PART CODE	QTY	DESCRIPTION
E	12	Roof End Piece 203x70x30mm
65BS	12	65 Batten Screws

4.6 - ASSEMBLY – ROOF END PIECES TO GABLES

Standing inside shed on ladder, screw roof end pieces to top of gable in required positions using 1x 65BS per piece. See positions in photo below. Lay 70mm side flat on top of gable with 70x30mm face flush with inside of gable frame and screw in place (6 pieces per gable).

Note: It is advised to predrill through the E first with a 4mm drill bit, before securing to gable.

Repeat this step on both gables.



STEP 4.7

ROOF INSTALLATION

4.7 - ASSEMBLY PARTS – ROOF INSTALLATION		
PART CODE	QTY	DESCRIPTION
	2	Completed roof panels
75BS	20	75mm Batten Screw
125BS	4	125mm Batten Screw

4.7 - ASSEMBLY – ROOF INSTALLATION

Slide roof frame into position. Ensure point of roof frame is flush with middle of gable as seen below. Fasten to ends using 3x 75BS, screw through roof frame into gable frame. Fasten to sides using 4x 75BS evenly spaced, screw through roof frame into side wall top plates, use 125BS for middle of side through JP. Meet second roof frame up with the first and repeat steps for fastening.

This task will require 2 or more persons to complete.

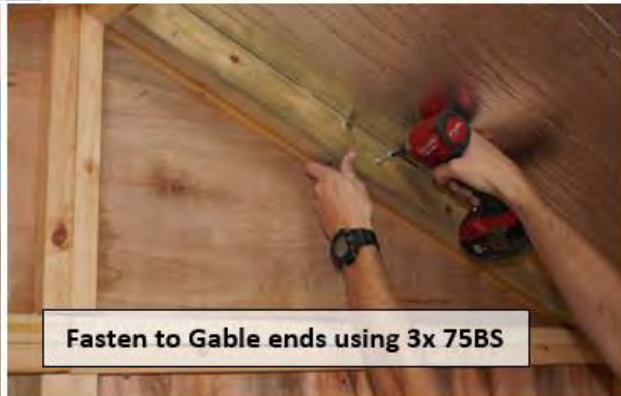

STEP 4.8

ROOF INSTALATION

4.8 - ASSEMBLY – ROOF INSTALLATION

PART CODE	QTY	DESCRIPTION
40RS	8	40mm Roof Screws
25RS	8	25mm Roof Screws

4.8 – ASSEMBLY – ROOF INSTALLATION

Fully fasten down the roof sheeting onto the Roof End Pieces (E) as seen below. Use 2x 25RS to screw into the top E of each side and 2x 40RS to screw into the bottom E of each side.

Note: there is four sides.



STEP 4.9

COLLAR TIE INSTALLATION

4.9 – ASSEMBLY PARTS – COLLAR TIE INSTALLATION

PART CODE	QTY	DESCRIPTION
CT	2	Collar tie
40RS	12	40mm Roof Screw
125BS	12	125mm Batten Screw

4.9 - ASSEMBLY – COLLAR TIE INSTALLATION

Holding Collar tie tight and level in position screw through CT into Roof Rafters in predrilled holes, using 6x 40RS per collar tie.

Fasten roof frames together by screwing 125BS evenly space along the top of the roof frames.



If Double door option was chosen please go to step 5.4

STEP 5.0

SINGLE DOOR HINGE ASSEMBLY

5.0 - ASSEMBLY PARTS – SINGLE DOOR HINGE ASSEMBLY

PART CODE	QTY	DESCRIPTION
H	3	Hinge
HS	9	Hinge Screw
CD	1	Door

5.0 - ASSEMBLY – SINGLE DOOR HINGE ASSEMBLY

Place door on back and hold hinge (H) in position. Fasten hinges to outside of door as seen below using 3x hinge screws (HS) per hinge.

Hinges are to be placed at top, middle and bottom of door, central with bracing seen at back of door.



Place hinges central over bracing on back of door. Top, middle & bottom.

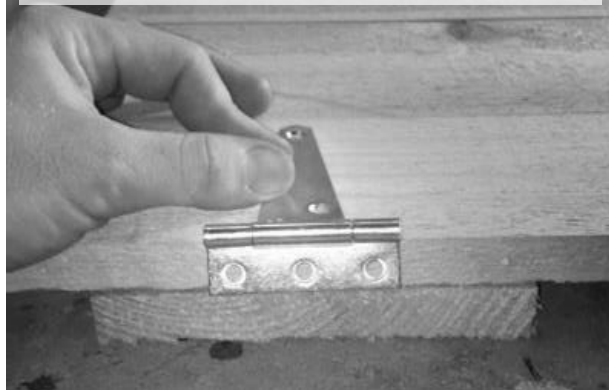

STEP 5.1

SINGLE DOOR INSTALLATION

5.1 - ASSEMBLY PARTS – SINGLE DOOR INSTALLATION

PART CODE	QTY	DESCRIPTION
SCD	1	Single Colonial Door
HS	9	Hinge screw

5.1 - ASSEMBLY – SINGLE DOOR INSTALLATION

Hold door in position, 3mm down from top. Front of the door when closed will be flush with front of VJ cladding. Screw through hinge into front wall using 3x HS per hinge (as pictured).



STEP 5.2

SINGLE DOOR HANDLE ASSEMBLY

5.2 - ASSEMBLY PARTS – SINGLE DOOR HANDLE ASSEMBLY

PART CODE	QTY	DESCRIPTION
TH	1	T Handle kit

5.2 - ASSEMBLY – SINGLE DOOR HANDLE ASSEMBLY

1. Remove bolts and lever from back of T Handle (TH).
2. Mark and drill 12mm centre hole in centre of middle door brace, 50mm in from door edge.
3. Insert T-handle in 12mm hole and mark two outside holes. Remove T-handle and drill a 6mm hole where marked.
4. Insert T-handle in hole again and secure with 5mm bolts inserted in front and washers and nuts tightened at back.



STEP 5.3

SINGLE DOOR HANDLE ASSEMBLY

5.3 - ASSEMBLY PARTS – SINGLE DOOR HANDLE ASSEMBLY

PART CODE	QTY	DESCRIPTION
	1	T Handle Lever

5.3 - ASSEMBLY – DOOR HANDLE ASSEMBLY

Holding door in closed position, flush with VJ cladding on front - slide lever onto T Handle and tighten once hitting on wall stud beside door.

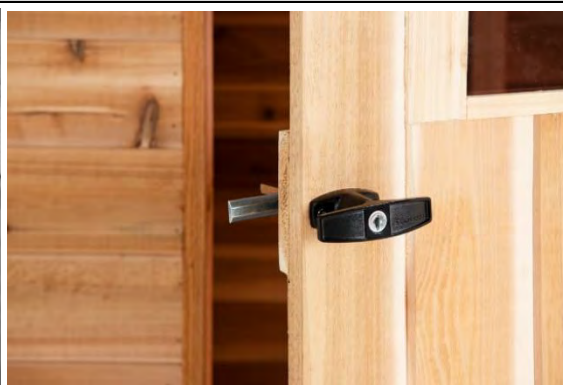

If Double door option was not chosen please go to step 5.9

STEP 5.4

DOUBLE DOOR HINGE ASSEMBLY

5.4 - ASSEMBLY PARTS – DOUBLE DOOR HINGE ASSEMBLY

PART CODE	QTY	DESCRIPTION
H	6	Hinge
HS	18	Hinge Screw
DCD	2	Double Colonial Doors

5.0 - ASSEMBLY – DOUBLE DOOR HINGE ASSEMBLY

Place door on back and hold hinge (H) in position. Fasten hinges to outside of door as seen below using 3x hinge screws (HS) per hinge.

Hinges are to be placed at top, middle and bottom of door, central with bracing seen at back of door.



Place hinges central over bracing on back of door. Top, middle & bottom.

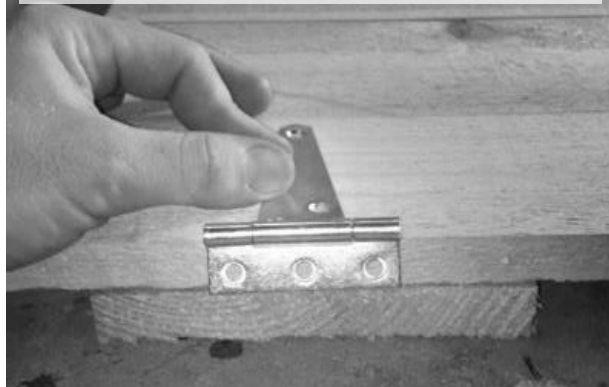

Repeat Step 5.4 with second door.



STEP 5.5

DOUBLE DOOR INSTALLATION

5.5 - ASSEMBLY PARTS – DOUBLE DOOR INSTALLATION

PART CODE	QTY	DESCRIPTION
CD	2	Doors
HS	18	Hinge screw

5.5 - ASSEMBLY – DOUBEL DOOR INSTALLATION

Hold door in position, 3mm down from top. Front of the door when closed will be flush with front of VJ cladding. Screw through hinge into front wall using 3x HS per hinge (as pictured). Repeat steps with second door.



STEP 5.6

PAD BOLT INSALLATION

5.6 - ASSEMBLY PARTS – PAD BOLT INSTALLATION

PART CODE	QTY	DESCRIPTION
PB	2	Pad bolt
PBS	8	Pad bolt screws

5.6 - ASSEMBLY – PAD BOLT INSTALLATION

Choose fixed door (generally left hand door). Hold top Pad bolt in position and fasten to door using 4x PBS. Hold door in closed position, mark centre of bolt and drill 10mm hole. Repeat for bottom pad bolt.

Note- T-Handle must be installed on the opposite door to the fixed door (door with barrel bolts).



STEP 5.7

DOUBLE DOOR HANDLE ASSEMBLY

5.7 - ASSEMBLY PARTS – DOUBLE DOOR HANDLE ASSEMBLY

PART CODE	QTY	DESCRIPTION
TH	1	T Handle kit

5.7 - ASSEMBLY – DOUBLE DOOR HANDLE ASSEMBLY

1. Remove bolts and lever from back of T Handle (TH).
2. Mark and drill 12mm centre hole in centre of middle door brace, 50mm in from door edge.
3. Insert T-handle in 12mm hole and mark two outside holes. Remove T-handle and drill a 6mm hole where marked.
4. Insert T-handle in hole again and secure with 5mm bolts inserted in front and washers and nuts tightened at back.



STEP 5.8

DOOR HANDLE ASSEMBLY

5.8 - ASSEMBLY PARTS – DOUBLE DOOR HANDLE ASSEMBLY

PART CODE	QTY	DESCRIPTION
DP	1	Door Packer
40N	4	40mm Nail
	1	T Handle Lever / backing tongue

5.8 - ASSEMBLY – DOUBLE DOOR HANDLE ASSEMBLY

Holding DP in position, fasten to fixed door (door with pad bolts) using 4x 40N.

Holding door in closed position, flush with other door - slide lever onto T Handle and tighten once hitting packer on fixed door.

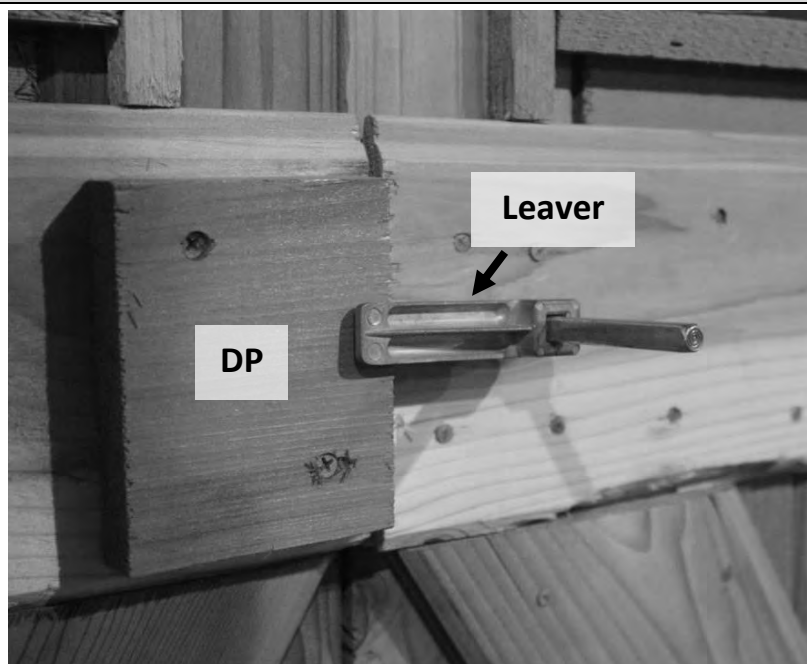

STEP 5.9

WINDOW ASSEMBLY INSTALLATION

5.9 - ASSEMBLY PARTS – WINDOW ASSEMBLY INSTALLATION

PART CODE	QTY	DESCRIPTION
WA	1	Window Assembly
32PS	20	32mm Phillips screw

5.9 - ASSEMBLY – WINDOW ASSEMBLY INSTALLATION

Fit Window Assembly into hole in Window Panel*. Ensuring the window frame is square, fasten to Window Panel by screwing through perimeter of Window Panel hole into WA**. Use 4x 32PS in top and bottom of WA and 6x 32PS for sides.

* Ensure window opens the side that suits you, flip Window Assembly to change.

** It is advised to predrill using a 3mm drill bit before screwing.

Repeat process for any additional windows.



STEP 6.0

INTERNAL WINDOW STRIP ASSEMBLY

6.0 - ASSEMBLY PARTS – INTERNAL WINDOW STRIP ASSEMBLY		
PART CODE	QTY	DESCRIPTION
SIWS	1	Internal Window Strip Set- 2@ 770mm, 2@ 735mm
40N	16	40mm Nail

6.0 - ASSEMBLY – INTERNAL WINDOW STRIP ASSEMBLY

1. Measure 25mm around perimeter of Window Panel hole.
2. Position and nail top 770mm strip using 4x 40N.
3. Position and Nail left side 735mm strip using 4x 40N.
4. Position and Nail right side 735mm strip and bottom 770mm strip together using 4x 40N for side and 4x 40N for bottom (adjust to line up).

Repeat process for any additional windows.

1. Measure 25mm around outside.

2. Nail top 770mm strip

3. Nail left 735mm strip

Nail 1x 40N in bottom & right strip and then align bottom right corner.

4. Align bottom right corner and then finish nailing bottom & right strips.



STEP 6.1

CORNER POST ASSEMBLY

6.1 - ASSEMBLY PARTS – CORNER POST ASSEMBLY		
PART CODE	QTY	DESCRIPTION
CP	4	1890mm Corner Post
40N	24	40mm Nail

6.1 - ASSEMBLY – CORNER POST ASSEMBLY

Hold corner post (CP) in position, nail through CP into wall stud using 6x 40N evenly spaced along CP. Repeat for all four corners.

Note: Before nailing CPs, we recommend running a bead of silicone down the lines seen below.

Recommended: Run a bead of silicone down these two lines before nailing CPs



STEP 6.2

COVER STRIP ASSEMBLY

6.2 - ASSEMBLY PARTS – COVER STRIP ASSEMBLY

PART CODE	QTY	DESCRIPTION
CP	5	1890mm Cover Strip
40N	30	40mm Nail

6.2 - ASSEMBLY – COVER STRIP ASSEMBLY

Hold cover strips (CS) over joins in walls, nail through CS into wall panel using 6x 40N evenly spaced per CS.

Note: Before nailing CS, we recommend running a bead of silicone down the joins in the wall, as seen below.

Recommended: Run a bead of silicone down joins before nailing CS



Nail 6x 40N evenly spaced along CS



STEP 6.3

FASCIA ASSEMBLY

6.3 - ASSEMBLY PARTS – FASCIA ASSEMBLY

PART CODE	QTY	DESCRIPTION
F	4	6ft Fascia
40N	12	40mm Nail

6.3 - ASSEMBLY – FASCIA ASSEMBLY

Hold fascia's in position. Flush with bottom of battens and joining evenly at the top.



STEP 6.4

RIDGE CAP INSTALLATION

6.4 - ASSEMBLY PARTS – RIDGE CAP INSTALLATION

PART CODE	QTY	DESCRIPTION
RC	3	1520mm Ridge Cap
40RS	8	40mm Roof screw

6.4 - ASSEMBLY – RIDGE CAP INSTALLATION

Slide ridge cap into position. Make sure peak of ridge cap is in line with peak of fascia's.

Screw through ridge cap into 2nd rib in from end and through into batten.

Slide second and third ridge cap into position and fasten at opposite end. Ensure ridge cap is straight and fasten through the centre overlaps, both sides.



STEP 6.5

FIXING TO BASE

6.5 - FIXING TO BASE

PART CODE	QTY	DESCRIPTION
65HHS	13	65mm Hex head screw

6.5 - FIXING TO BASE

Screw through base plates on wall frames in positions shown below using 65HHS screws. If floor not purchased fixings are not provided

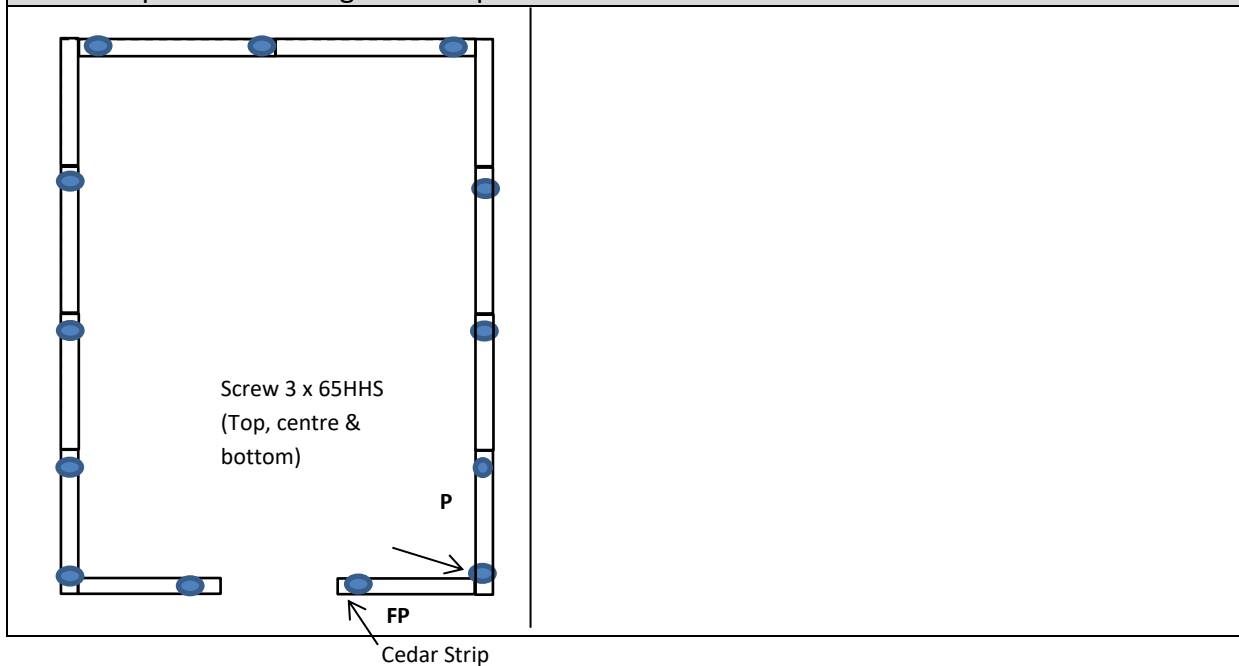

If installing on a concrete slab – use 100mm long 10mm round dyna bolts through frame in the same positions.



IMAGES TO HELP WITH INSTALLATION

FLOOR









TO REGISTER YOUR WARRANTY

Thank-you for purchasing a STILLA product. To register your 10 year product warranty, please go to www.stilla.com.au/warranty and complete the online form. We recommend that you complete this step once you have finished installing your product.

PLEASE NOTE THAT IF YOU DO NOT COMPLETE THIS WARRANTY REGISTRATION FORM – YOUR PRODUCT IS NOT COVERED BY WARRANTY.

PRODUCT MAINTENANCE

We highly recommend you coat the external of your product with Intergrain UltraDeck Timber Stain – in the Colour Light Oak. This product is available from Dulux paint stores or Bunnings stores that have a paint section. The product is re tinted from a Cedar Cypress base to achieve the light oak colour – Intergrain is a Cabot's product (Having issues – Bring up Cabot's page on the paint desk computer and type Light Oak – this should bring up the formula)



17/10/2023

SHOW US YOUR SHED

We would love to see a photo of your STILLA product installed in your backyard. Please upload this image when completing the warranty registration. Alternatively, you can send the photos by email to sales@stilla.com.au.

If you require any assistance, please feel free to call or email.

Kind regards,

STILLA Customer Support

1800 784 552 | sales@stilla.com.au

