

STILLA

ASSEMBLY INSTRUCTIONS



‘Jacaranda’ 10x20

S3071

Every part needed to construct your shed is included inside the pack; cedar panels, doors, windows, hardware kits & roof sheeting. Please ensure you fully unpack all the parts & check against the parts checklist before contacting customer service about anything you believe may be missing. Thank-you!

Caution

Please be careful when handling all components, some parts have sharp metal edges. Always wear work gloves, eye protection and long sleeves when assembling or maintaining your shed.

Tools required for assembly

- Level
- Drill (capable of driving 100mm Batten Screw)
- Hammer
- Ladder
- 10mm Drill bit
- 6mm Drill bit
- Tape measure
- Phillips head drive
- Hex Head Drive (5/16')
- Safety glasses
- Gloves
- Circular/power saw (if heavy duty floor was chosen)
- 4mm Alan key
- Batten screw drive

Before assembly

- Before proceeding with installation, we recommend viewing the Cedar Studio video at www.stilla.com.au/installation/ or search Stilla Cedar Studios on Youtube. This doesn't show the installation in detail however it could give you some handy tips. Please note we haven't videoed the assembly of each shed however the video online is the Pioneer 20x10 and will give you an overall idea on how the installation process is completed.
- Remove all parts from packages and place in a safe place close to assembly area.
- Review all instructions; continue to refer to instructions throughout assembly – step by step.

Preparing your site

- If you are installing your shed on the Stilla heavy duty floor, this can be placed on unlevelled surfaces and levelled up by using the 100x100 stumps provided.



JACARANDA 10x20 PARTS CHECKLIST

Part Code	Checked	Part Description	Qty
P		Cedar Clad Ply Panel 1500x2020mm (replace 2 with WP if DD)	10
WP		Cedar Clad Ply Window Panel 1080x2020mm (remove if DD)	2
SWA		Cedar Studio Window Assembly (add per additional WP)	2
SCD		Single Colonial Door 825x1885mm (remove if DD)	1
G		10ft Ply Gable	4
WP		Cedar Clad Ply Window Panel 1500x2020mm (DD option)	2
FWP		Cedar Clad Ply Fixed Window Panel 1500x2020mm (option)	
FP		Cedar Clad Ply Front Panel 780x2020mm (DD option)	2
DCD		Double Colonial Door 710x1885mm (DD option)	2
CP		Corner Post 2015x65x18mm	4
CS		Cover Strip 2015x40x7mm	9
CS		Fixed Cover Strip 2015x40x7mm (4x per added fixed window)	
SF		10ft Studio Fascia Pack (4pcs) - 140x20mm	1
R		Roof Rafter 1520x70x45mm	10
LCT		Large Collar Tie	2
SDH		Single Studio Door Head 840x123x45mm	1
SDSS		Single Door Surround Set – 2@ 840mm, 2@ 1870mm (17x17)	1
DDH		Studio Double Door Head 1440x123x45mm	1
DDSS		Double Door Surround Set – 2@ 1440mm, 2@ 1870mm (17x17)	1
DDS		Double Door Vertical Seal – 1855x55x20mm	1
SIWS		Studio Internal Window Strip Set – 2@ 770mm, 2@ 1240mm (add per additional WP)	2
FGS		Front Gable Cover Strip – 580mm	1
BGS		Back Gable Cover Strip – 610mm	1
SCS		Stilla Cover Strip 3000x40x7mm (1@1800mm, 1@ 1200mm)	1 & 1
E		Roof End Piece 203x70x30mm	12
RSB		Roof Support Block 250x70x45mm	2
RS		1800mm Roof Sheet	16
RS		1800mm Roof Sheet Double Pan	2
Sky		1800 Skylight (option- swap with 1800 roof sheet)	
RC		1800mm Ridge Cap	4
C		1580mm Channel	8
HK		10x20 Hardware Kit	1
IM		10x20 Instruction Manual	1
REP		Roof End Plate 1968x70x45mm	8
MREP		Middle Roof End Plate 1968x70x45mm	4
JP		Joining Plate 1433x70x45mm	8
RI (option)		Roof Insulation 1600x1300mm	10

Floor Kit – Option

Floor Frame – 140x35

Part Code	Checked	Part Description	Qty
EP		Floor End Plate 1542x140x35mm	12
SJ		Floor Single Joist 1930x140x35mm	24
DJ		Floor Double Joist 1930x140x35mm	6
FN		Floor Nog 333x42x35mm	15
L		Logs 750mm	12
FB		Floorboard 1798x800mm	7
FB		Floorboard 1198x800mm	7
FB		Floorboard 1798x306mm	1
FB		Floorboard 1198x306mm	1

Annex Kit – Option (add screws)

6320mm x 1450mm

Part Code	Checked	Part Description	Qty
VBJ		Veranda Beam Joiner 700x70x45mm	1
VOBJ		Veranda Outer Beam Joiner 700x140x35mm	1
VB		Veranda Beam 3160x70x45mm	2
VOB		Veranda Outer Beam 3160x140x35mm	2
VR		Veranda Rafter 1320x70x45mm	6
VF		Veranda fascia 1350x140x20 block cedar	2
VRS		1450mm Veranda Roof Sheet	9
VP		Veranda Posts 2400x90x90mm	4

Annex Deck Kit – Option (add screws)

6000mm x 1420mm

Part Code	Checked	Part Description	Qty
VEP		Veranda End Plate 4610x140x35mm	2
VSEP		Veranda Shorter End Plate 1390x140x35	2
VJ		Veranda Joists 1350x140x35	16
VFB		Veranda Floorboards 4635x140x20mm	11
VSFB		Veranda Shorter Floorboards 1415x140x20mm	11
VL		Veranda Logs 750x100x100mm	4



STEP 1.1

FLOOR NOG INSTALLATION (PRIOR TO JOINING FLOOR FRAME)

1.1 – FLOOR NOG INSTALLATION		
PART CODE	QTY	DESCRIPTION
FN	15	Floor Nog 333x42x35mm
65BS	30	65mm Batten Screws

1.1 – FLOOR NOG INSTALLATION
 Mark out measurements shown below (centre of nog). Fasten Floor Nogs (FN) in positions shown in diagram below using 1x 65BS per join.

The diagram illustrates the front view of a floor frame with six numbered sections (1-6) for floor nog installation. The sections are arranged in two rows of three. The top row contains sections 1, 2, and 3, while the bottom row contains sections 4, 5, and 6. Each section is a rectangular frame with three horizontal members. The dimensions are as follows:

- Section 1:** Total width 1476mm, distance from left edge to center of nog 1018mm.
- Section 2:** Total width 1076mm, distance from left edge to center of nog 618mm.
- Section 3:** Total width 1782mm, distance from left edge to center of nog 1324mm, distance from center of nog to right edge 280mm.
- Section 4:** Total width 1818mm, distance from left edge to center of nog 676mm.
- Section 5:** Total width 1831mm, distance from left edge to center of nog 1418mm.
- Section 6:** Total width 982mm, distance from left edge to center of nog 524mm.

Vertical dimensions for the sections are 218mm for sections 1, 2, and 3, and 276mm for sections 4, 5, and 6.



STEP 1.2

FLOOR FRAME INSTALLATION

The 10x20 floor frame comes in six parts. Install first floor frame in desired position at desired height and fasten to logs once level and square, then join and fasten next frame until all four are joined and secured to logs.

1.2 – FLOOR FRAME INSTALLATION

PART CODE	QTY	DESCRIPTION
L	12	Logs 750x100x100mm
100BS	48	100mm batten screws
65BS	42	65mm Batten Screws
200PB	12	200mm M12 Post Bolt
W	24	M12 Washers

1.2 – FLOOR FRAME INSTALLATION

Repeat the steps below for each floor frame, joining the floor frames together as you go in order displayed in diagram below.

1. Lay out frame in desired position and mark holes to dig, as indicated on diagram below (use shovel or marking paint).
2. Dig and place logs in holes (using concrete if you wish).
3. Fasten floor frame to logs at desired height, using 4x 100BS per log, ensuring frame is level*.
4. Butt next floor frame into last installed frame and join using 6x 65BS evenly spaced along EP or SJ.
5. Repeat process until all frames are joined.

* Fasten frame to logs when roughly level and then critique by hammering in or adding dirt (or concrete) to corners until perfectly level at every post.

Once all frames are joined, predrill holes (using a 13mm drill bit) and bolt each log to the floor frame in spots indicated with 200PB, using washers on both sides.

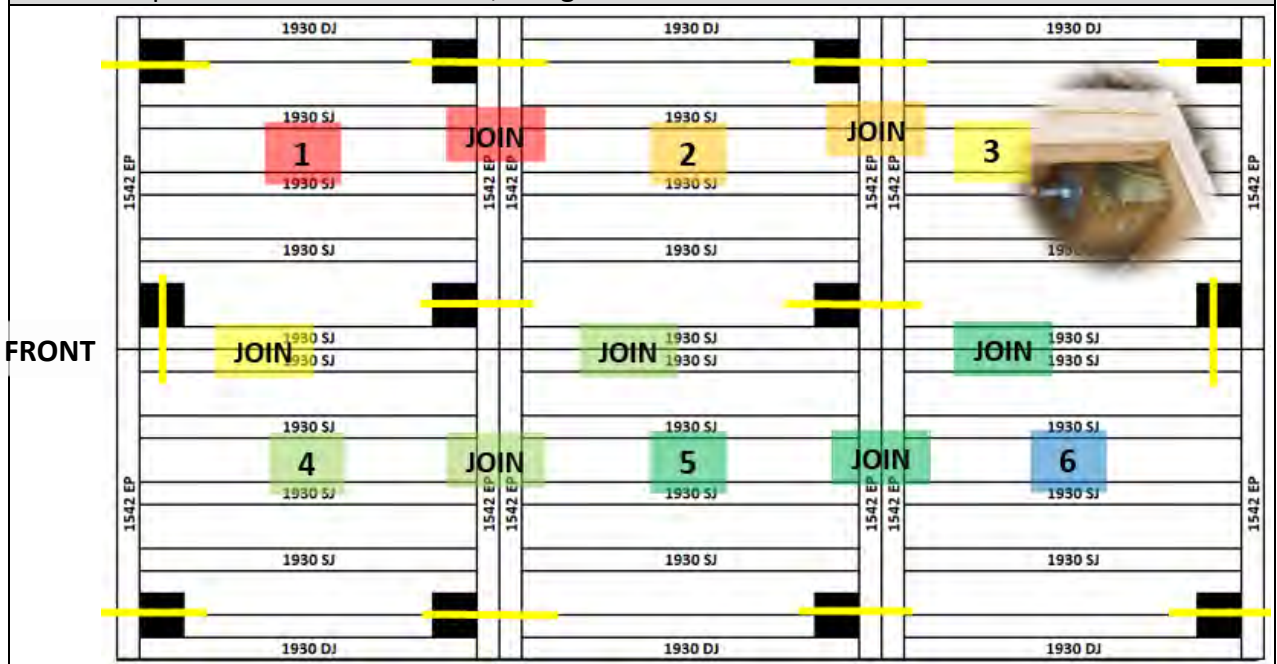

STEP 1.3

FLOOR INSTALLATION

1.3 – FLOORING INSTALLATION		
PART CODE	QTY	DESCRIPTION
FB	7	Floor Board 1798x800mm
FB	7	Floor Board 1198x800mm
FB	1	Floor Board 1798x306mm
FB	1	Floor Board 1198x306mm
50PS	237	50mm Philips Screw

1.3 – FLOORING INSTALLATION

Fasten floor sheets to floor frame as shown in diagram below using 50PS.
 Bring Floor sheets in **47mm** on two EP sides from the outside of the floor frame and **44mm** from the two DJ sides as seen below.

Note- The x marked on the floor sheets do not line up with our joists.

FRONT

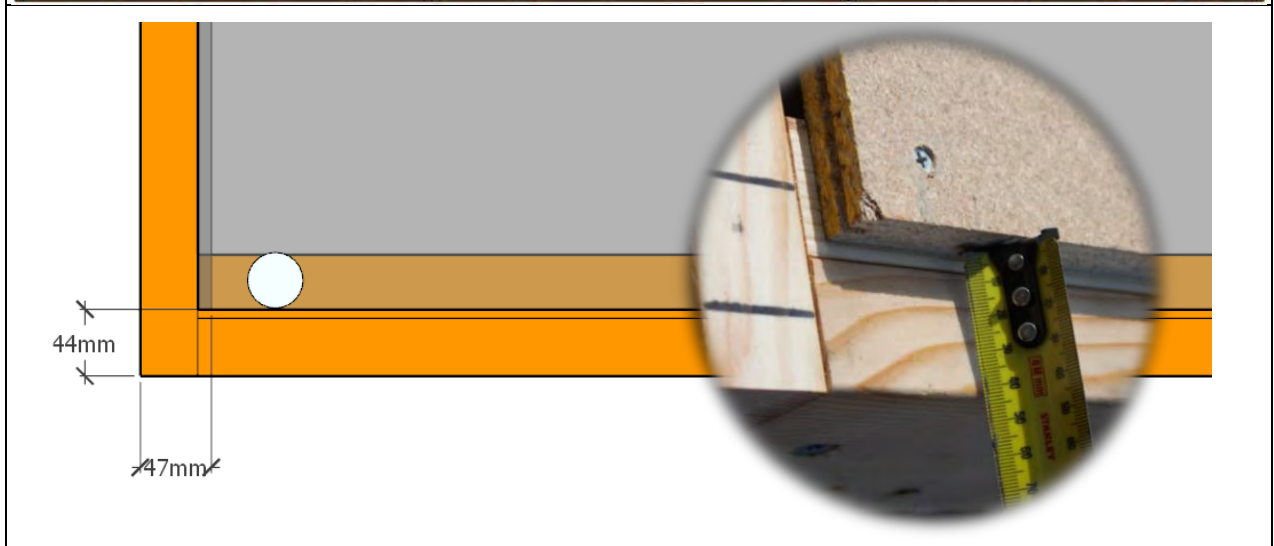
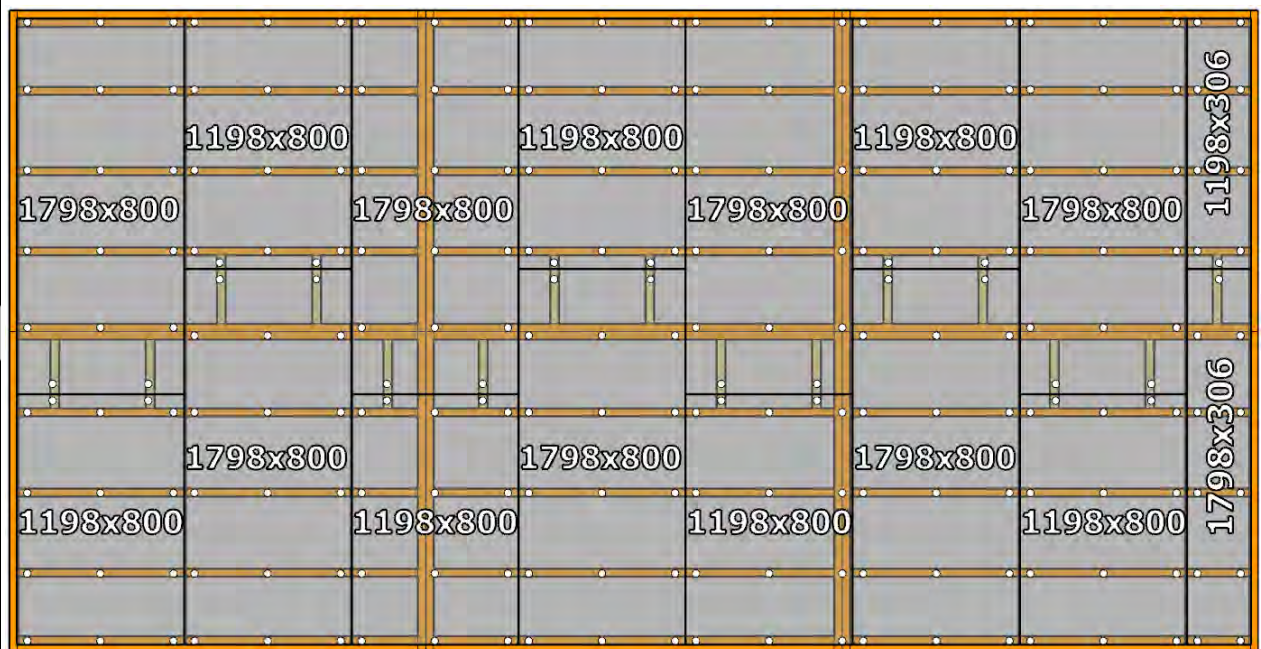

STEP 2.0

SINGLE DOOR WALL PANEL LAYOUT

The 10x20 Jacaranda comes standard with a single door in the gable end of the shed with two window panels either side, as seen in the plan below. Follow the steps outlined in the following pages to assemble this plan in the correct order.

Note: Any additional window panels purchased can be positioned and replace any of the 1500 panels (P) seen on this plan.

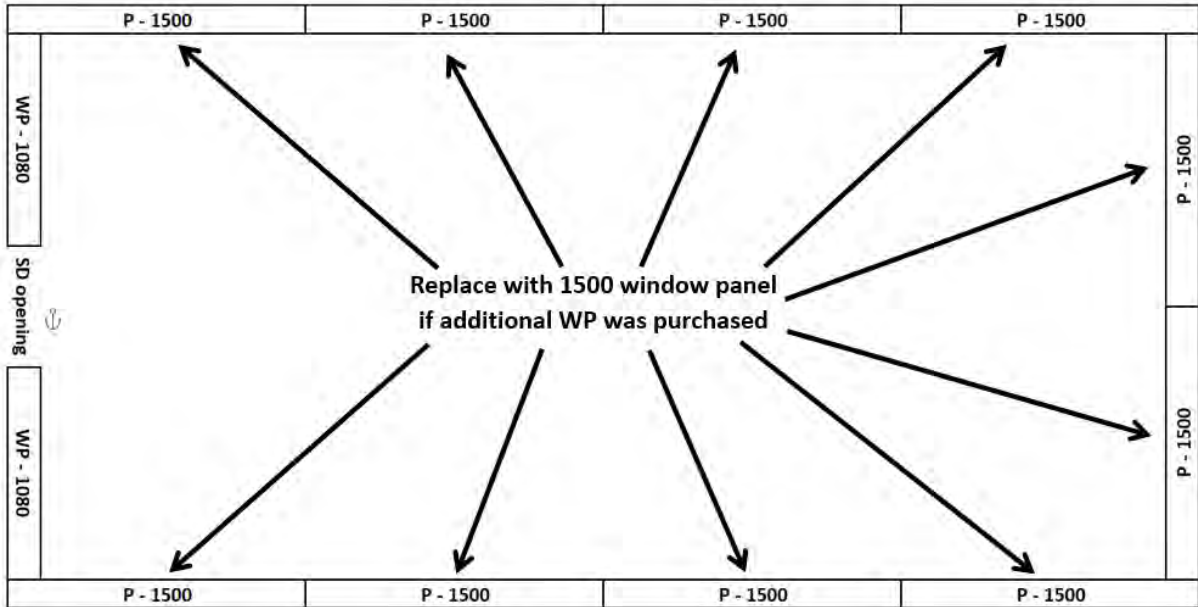

DOUBLE DOOR WALL PANEL LAYOUT (OPTION)

The double door option includes double doors in the gable end of the shed with two front panels either side and windows in the side wall, as seen in the plan below.

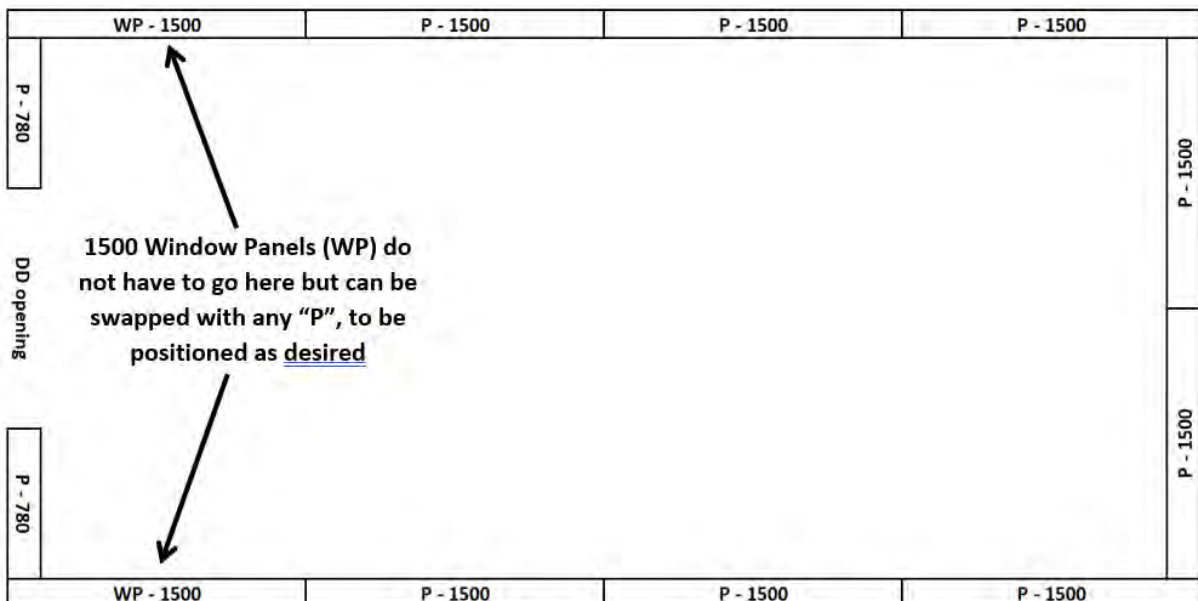

STEP 2.1

WALL ASSEMBLY

2.1 - ASSEMBLY PARTS – WALL ASSEMBLY		
PART CODE	QTY	DESCRIPTION
FWP	1	1080mm Front Window Panel (replace with FP if DD)
FP	1	780mm Front Panel (ONLY IF DOUBLE DOOR OPTION PURCHASED)
P	1	1500mm Panel (Replace with WP if DD)
65HHS	3	65mm Hex head screw

2.1 - ASSEMBLY – WALL ASSEMBLY

Screw through FWP into P (top, centre & bottom) using 3 x 65HHS*.

Cedar strip on FWP or FP should be on the door side.

** It helps to have one person adjusting from the outside and one person screwing on the inside.*

Note: Ensure tongue on cedar cladding is at top.

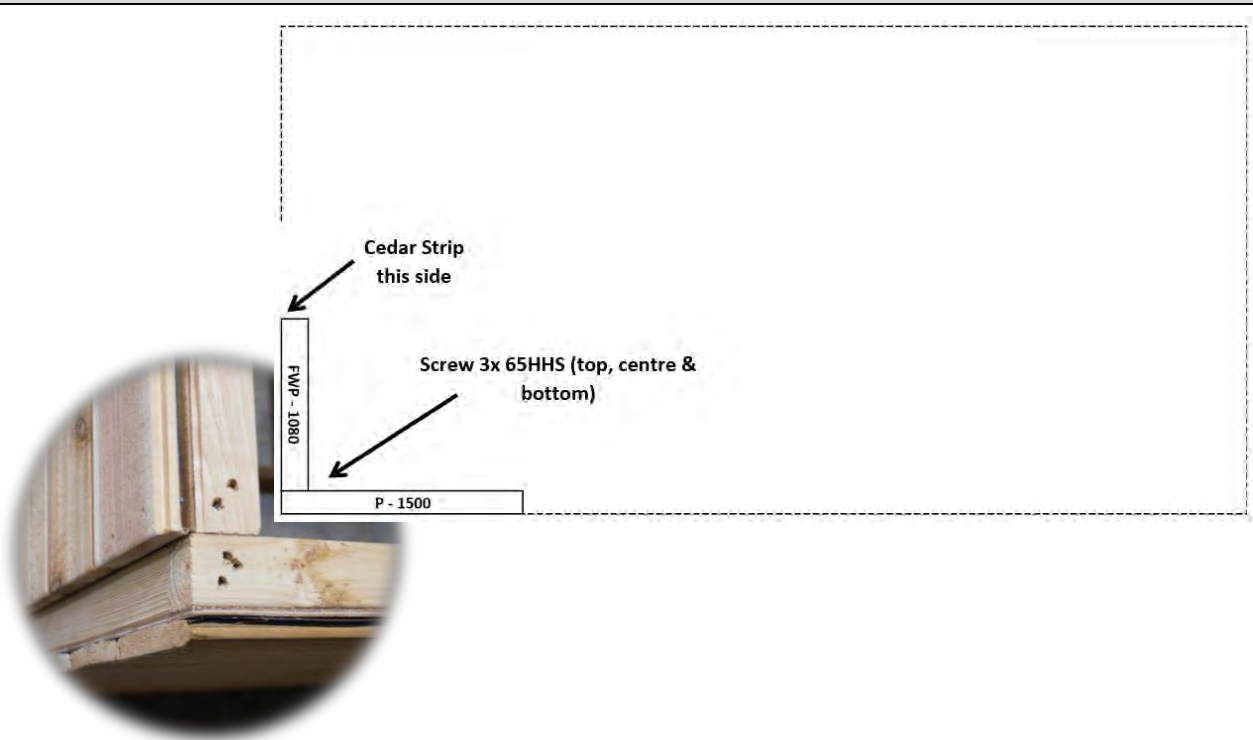

IMPORTANT CORNER DETAIL:
Install frame flush on the outside of plywood bracing.

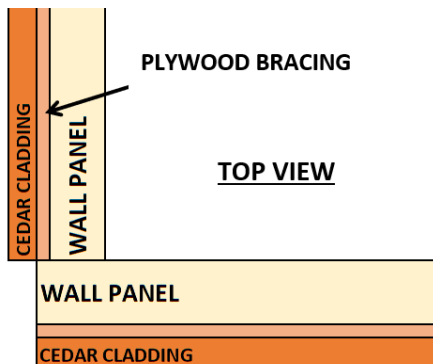

STEP 2.2

WALL ASSEMBLY

2.2 - ASSEMBLY PARTS – WALL ASSEMBLY

PART CODE	QTY	DESCRIPTION
P	1	1500mm Panel
65HHS	3	65mm Hex head screw

2.2 - ASSEMBLY – WALL ASSEMBLY

Screw through P into P (top, centre & bottom) using 3 x 65HHS*.

** It helps to have one person adjusting from the outside and one person screwing on the inside.*

Note: Ensure tongue on cedar cladding is at top.

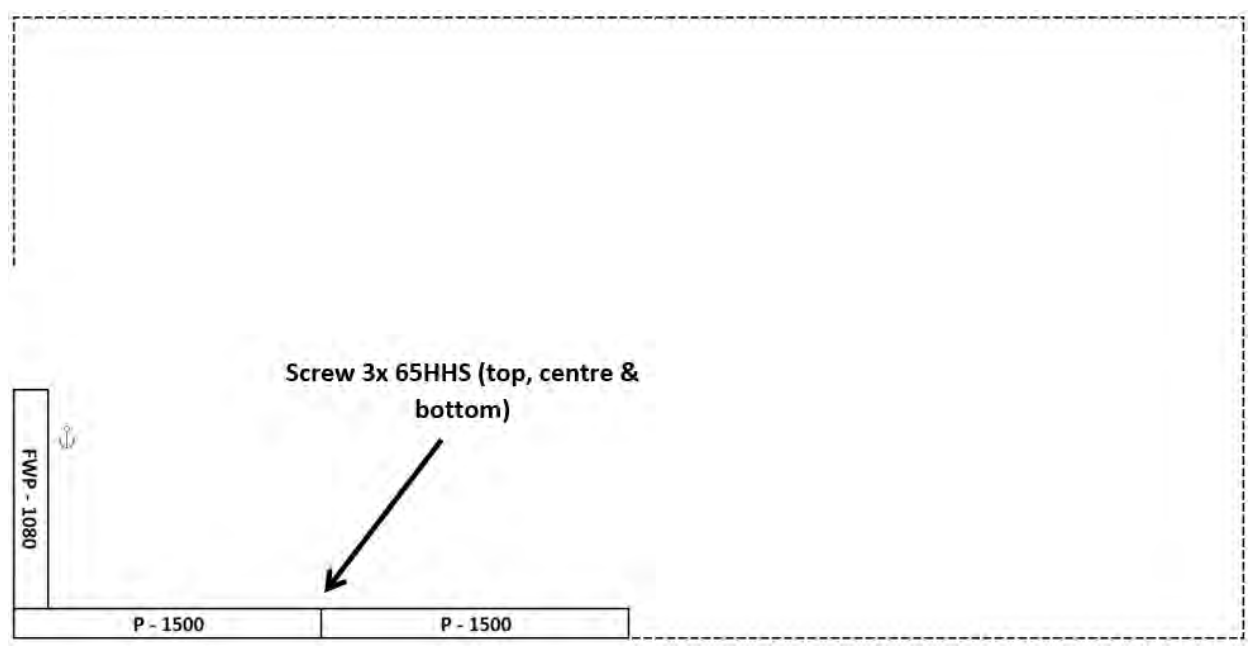

STEP 2.3

WALL ASSEMBLY

2.3 - ASSEMBLY PARTS – WALL ASSEMBLY

PART CODE	QTY	DESCRIPTION
P	1	1500mm Panel
65HHS	3	65mm Hex head screw

2.3 - ASSEMBLY – WALL ASSEMBLY

Screw through P into P (top, centre & bottom) using 3 x 65HHS*.

** It helps to have one person adjusting from the outside and one person screwing on the inside.*

Note: Ensure tongue on cedar cladding is at top.

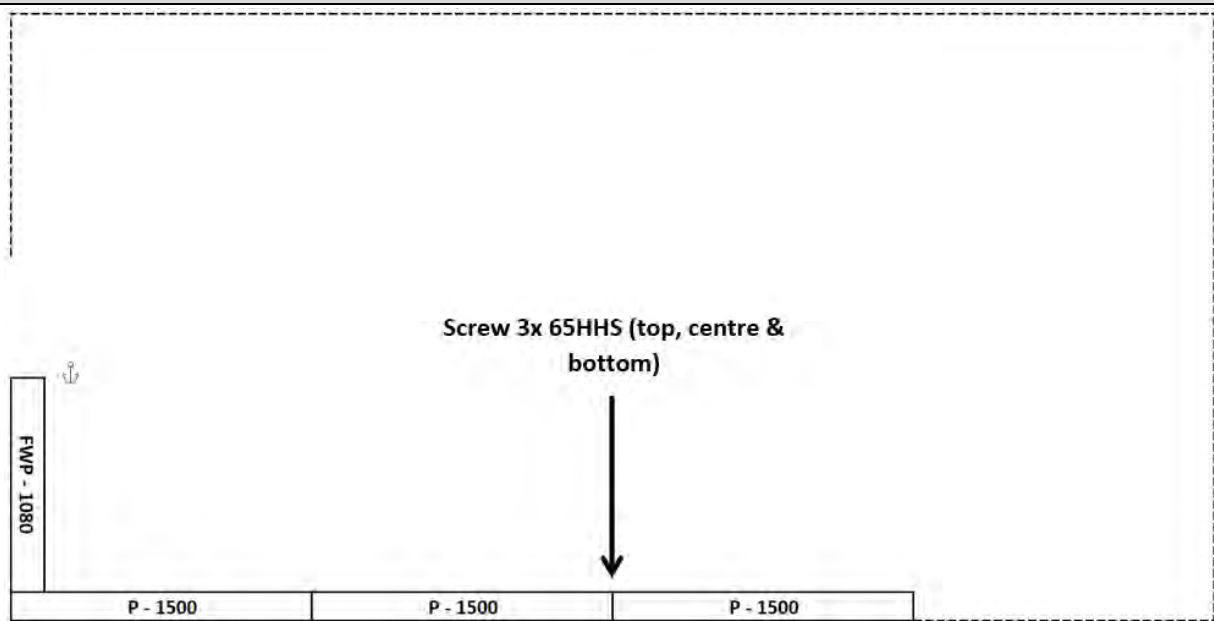

STEP 2.4

WALL ASSEMBLY

2.4 - ASSEMBLY PARTS – WALL ASSEMBLY

PART CODE	QTY	DESCRIPTION
P	1	1500mm Panel
65HHS	3	65mm Hex head screw

2.4 - ASSEMBLY – WALL ASSEMBLY

Screw through P into P (top, centre & bottom) using 3 x 65HHS*.

** It helps to have one person adjusting from the outside and one person screwing on the inside.*

Note: Ensure tongue on cedar cladding is at top.

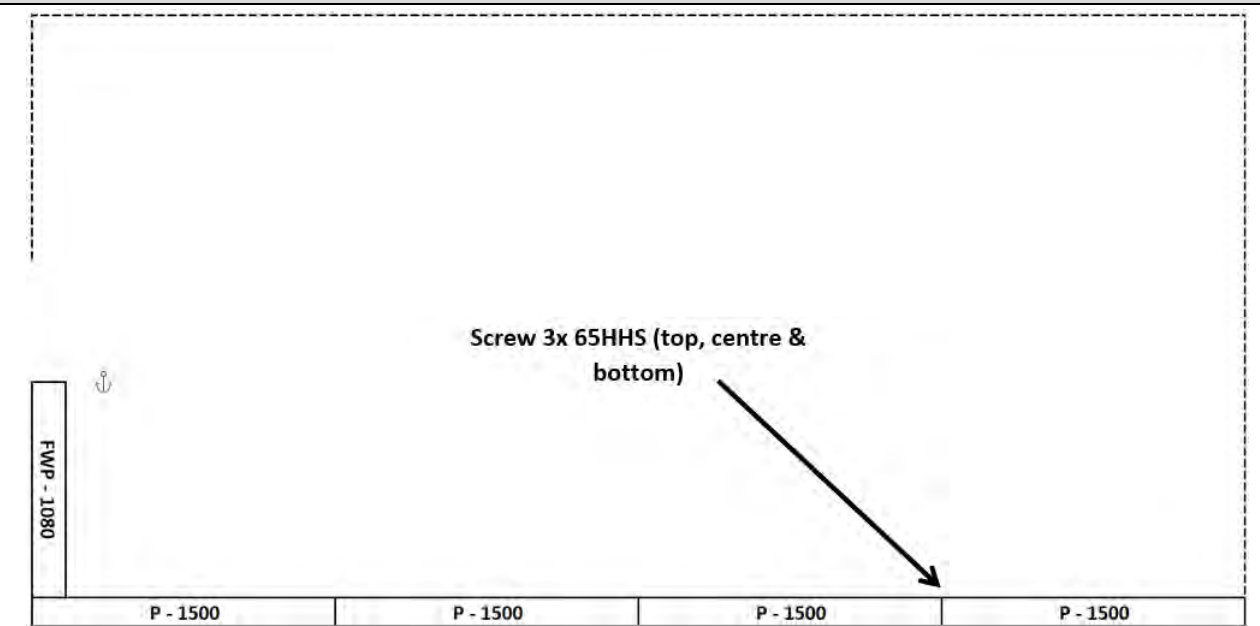

STEP 2.5

WALL ASSEMBLY

2.5 - ASSEMBLY PARTS – WALL ASSEMBLY		
PART CODE	QTY	DESCRIPTION
P	1	1500mm Panel
65HHS	3	65mm Hex head screw

2.5 - ASSEMBLY – WALL ASSEMBLY
 Screw through P into P (top, centre & bottom) using 3 x 65HHS*.
** It helps to have one person adjusting from the outside and one person screwing on the inside.*
Note: Ensure tongue on cedar cladding is at top.

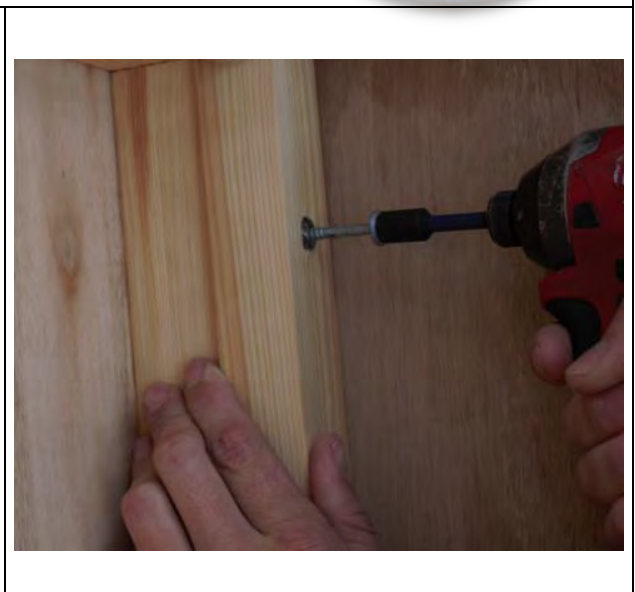
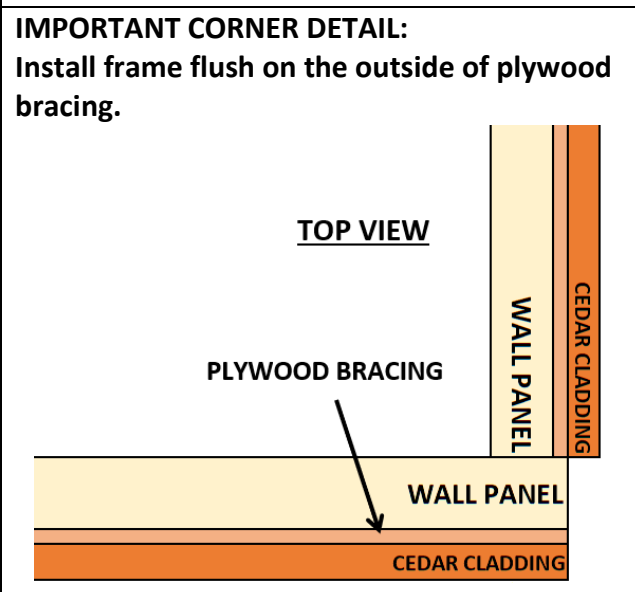
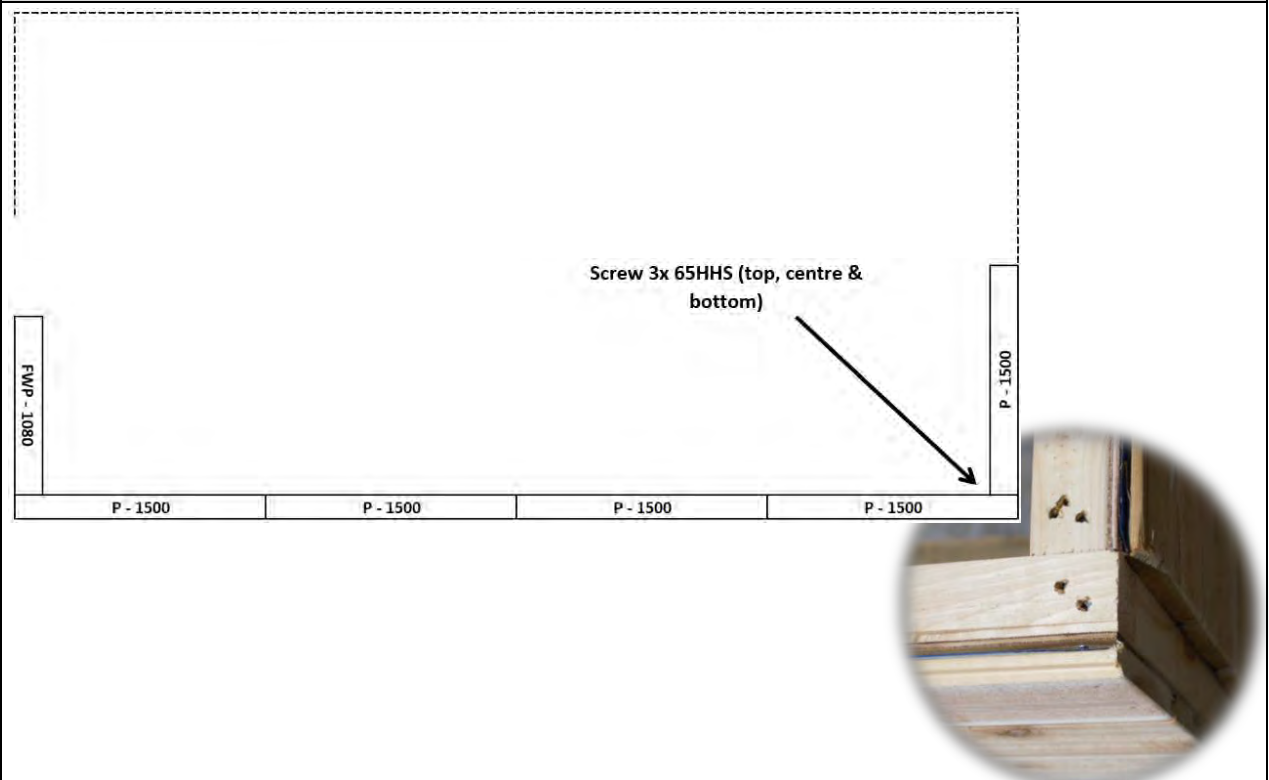

STEP 2.6

WALL ASSEMBLY

2.6 - ASSEMBLY PARTS – WALL ASSEMBLY

PART CODE	QTY	DESCRIPTION
P	1	1500mm Panel
65HHS	3	65mm Hex head screw

2.6 - ASSEMBLY – WALL ASSEMBLY

Screw through P into P (top, centre & bottom) using 3 x 65HHS*.

** It helps to have one person adjusting from the outside and one person screwing on the inside.*

Note: Ensure tongue on cedar cladding is at top.

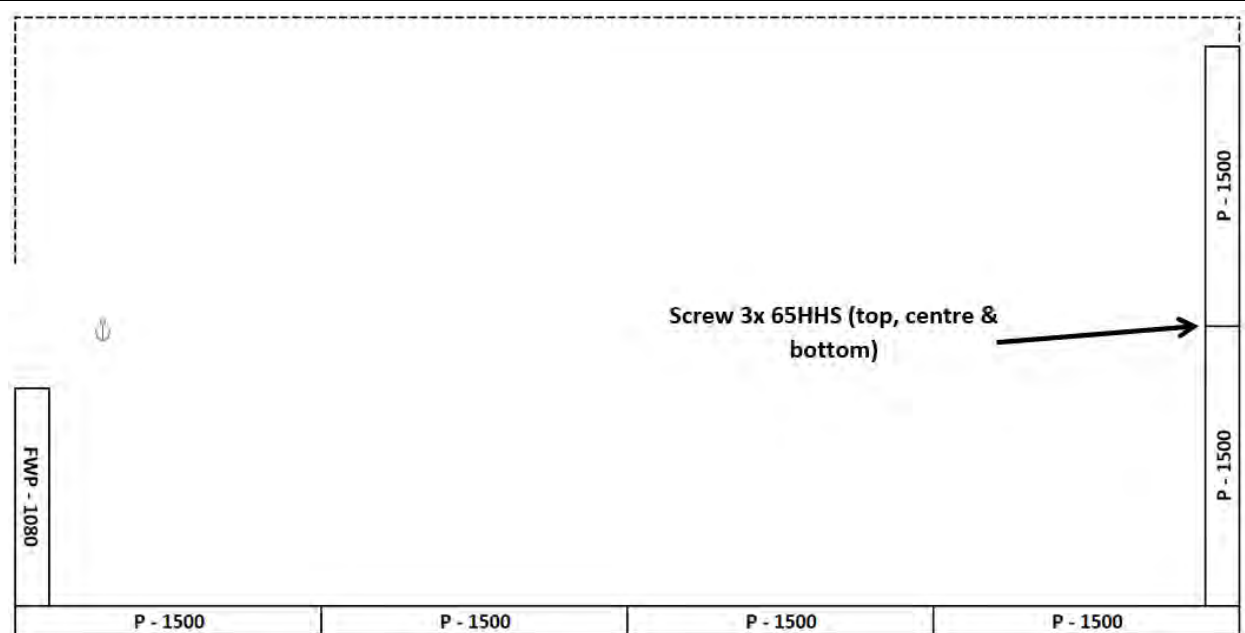

STEP 2.7

WALL ASSEMBLY

2.7 - ASSEMBLY PARTS – WALL ASSEMBLY

PART CODE	QTY	DESCRIPTION
P	1	1500mm Panel
65HHS	3	65mm Hex head screw

2.7 - ASSEMBLY – WALL ASSEMBLY

Screw through P into P (top, centre & bottom) using 3 x 65HHS*.

** It helps to have one person adjusting from the outside and one person screwing on the inside.*

Note: Ensure tongue on cedar cladding is at top.

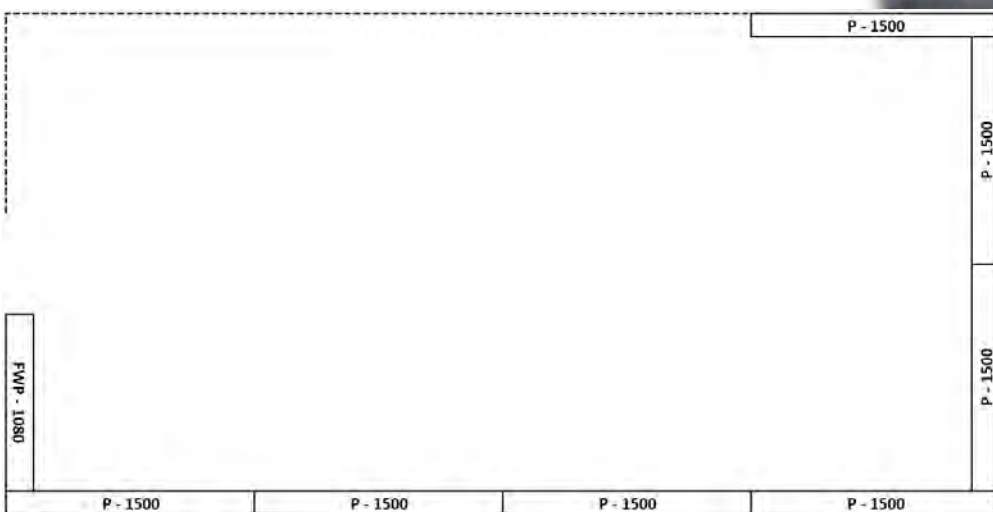

IMPORTANT CORNER DETAIL:
Install frame flush on the outside of plywood bracing.

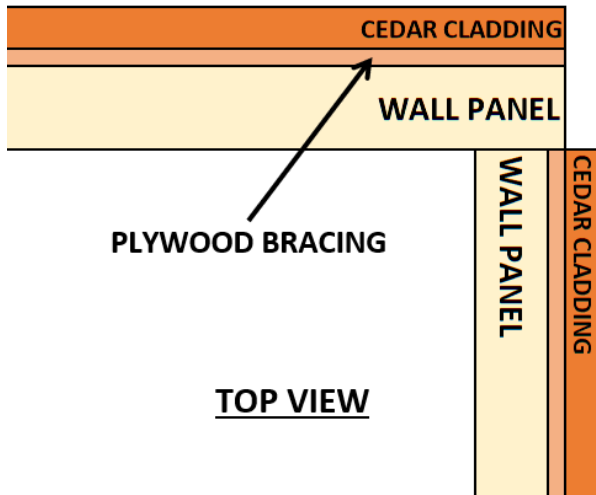

STEP 2.8

WALL ASSEMBLY

2.8 - ASSEMBLY PARTS – WALL ASSEMBLY

PART CODE	QTY	DESCRIPTION
P	1	1500mm Panel
65HHS	3	65mm Hex head screw

2.8 - ASSEMBLY – WALL ASSEMBLY

Screw through P into P (top, centre & bottom) using 3 x 65HHS*.

** It helps to have one person adjusting from the outside and one person screwing on the inside.*

Note: Ensure tongue on cedar cladding is at top.

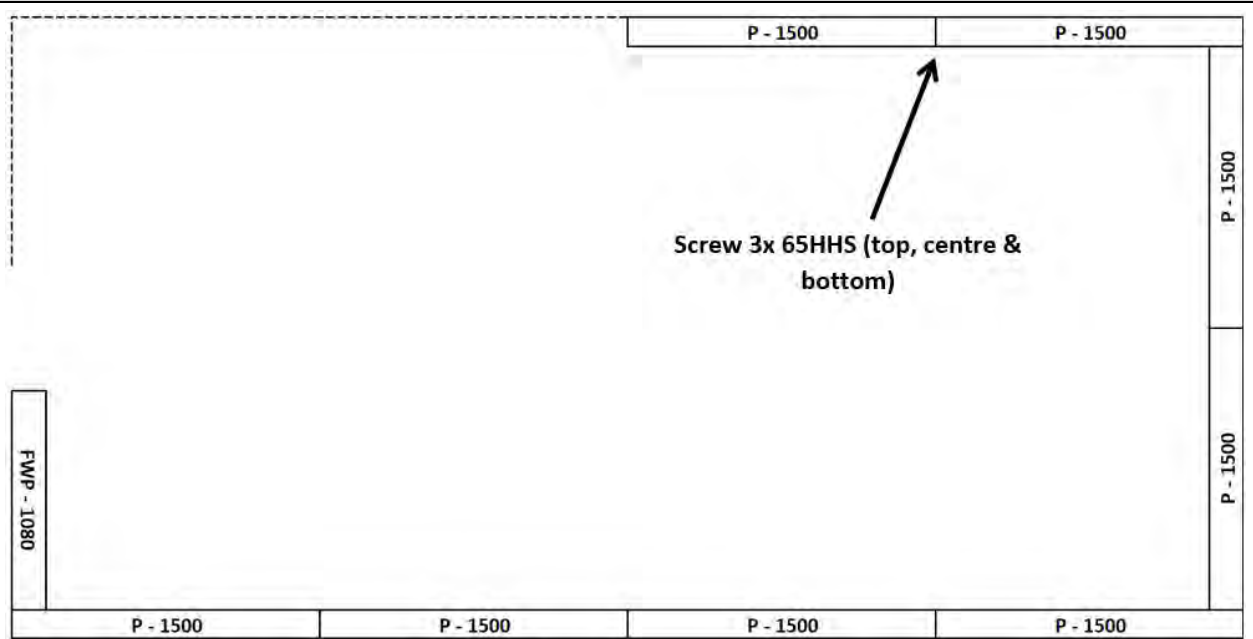

STEP 2.9

WALL ASSEMBLY

2.9 - ASSEMBLY PARTS – WALL ASSEMBLY

PART CODE	QTY	DESCRIPTION
P	1	1500mm Panel
65HHS	3	65mm Hex head screw

2.9 - ASSEMBLY – WALL ASSEMBLY

Screw through P into P (top, centre & bottom) using 3 x 65HHS*.

** It helps to have one person adjusting from the outside and one person screwing on the inside.*

Note: Ensure tongue on cedar cladding is at top.

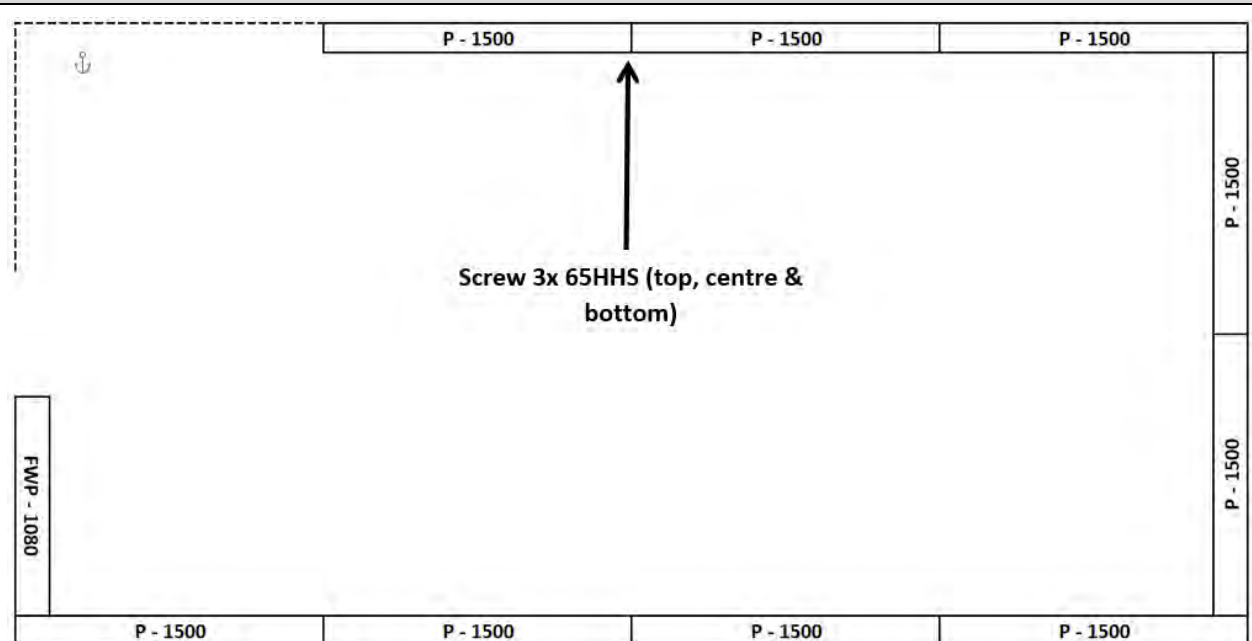

STEP 3.0

WALL ASSEMBLY

3.0 - ASSEMBLY PARTS – WALL ASSEMBLY

PART CODE	QTY	DESCRIPTION
P	1	1500mm Panel
65HHS	3	65mm Hex head screw

3.0 - ASSEMBLY – WALL ASSEMBLY

Screw through P into P (top, centre & bottom) using 3 x 65HHS*.

** It helps to have one person adjusting from the outside and one person screwing on the inside.*

Note: Ensure tongue on cedar cladding is at top.

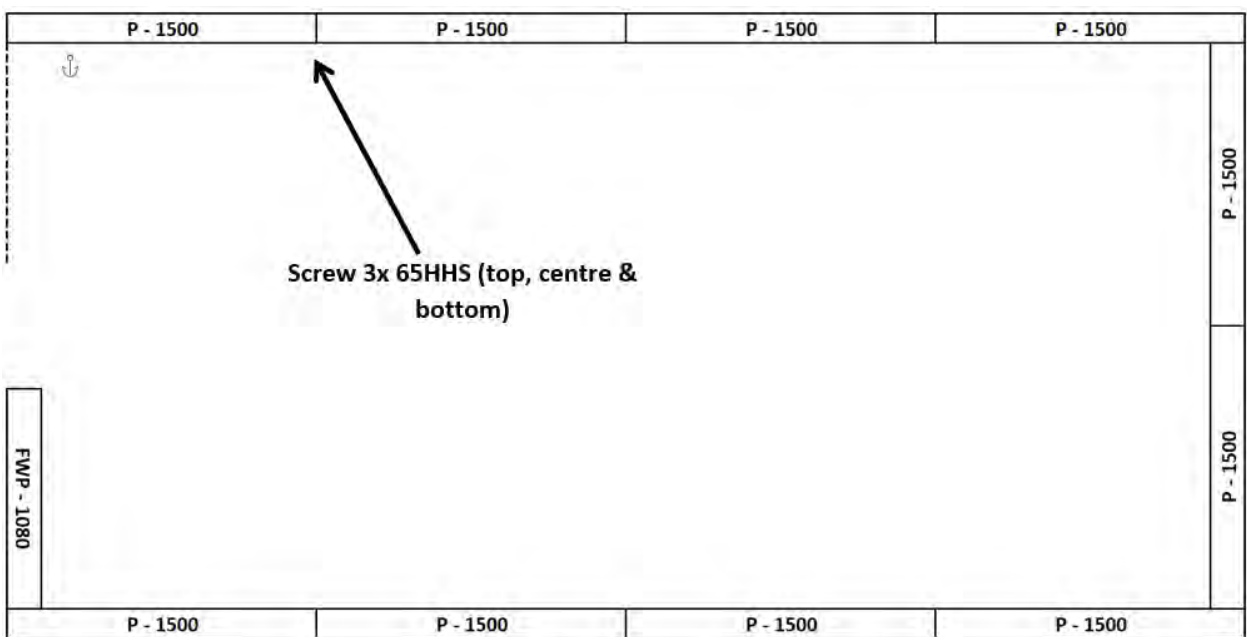

STEP 3.1

WALL ASSEMBLY

3.1 - ASSEMBLY PARTS – WALL ASSEMBLY

PART CODE	QTY	DESCRIPTION
FWP	1	1080mm Front Window Panel (Replace with FP if DD)
FP	1	780mm Front Panel (ONLY IF DOUBLE DOOR OPTION PURCHASED)
65HHS	3	65mm Hex head screw

3.1 - ASSEMBLY – WALL ASSEMBLY

Screw through P into P (top, centre & bottom) using 3 x 65HHS*. Cedar strip on FWP or FP should be on the door side.

** It helps to have one person adjusting from the outside and one person screwing on the inside.*

Note: Ensure tongue on cedar cladding is at top.

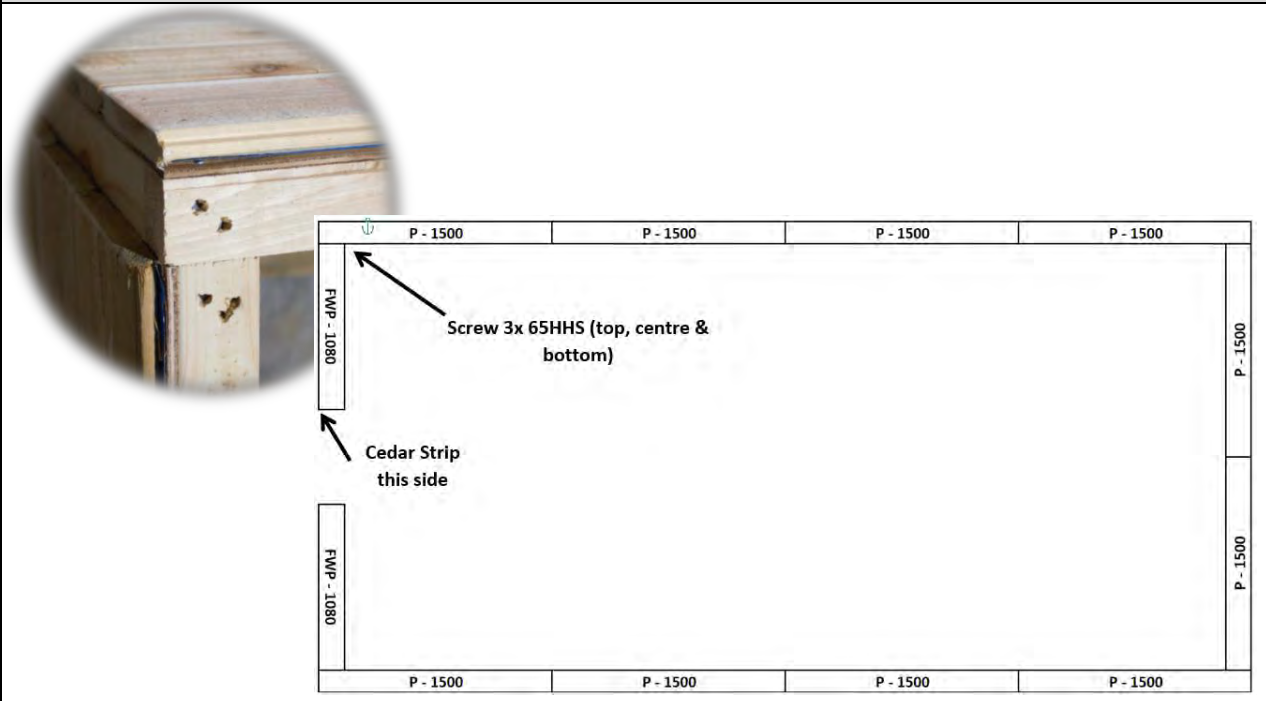

IMPORTANT CORNER DETAIL:
Install frame flush on the outside of plywood bracing.

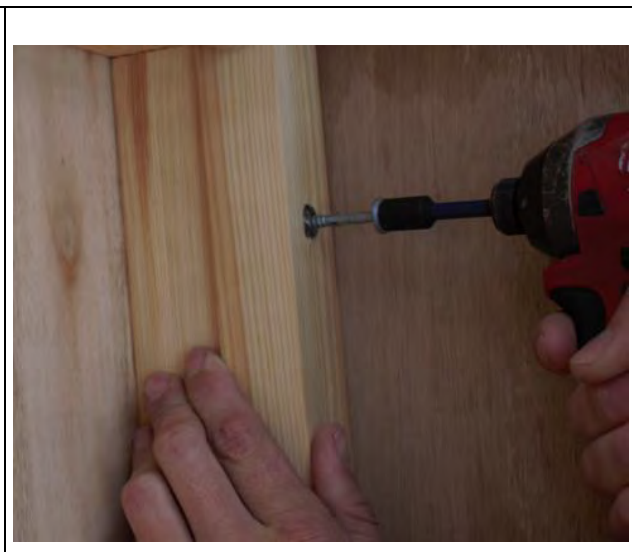
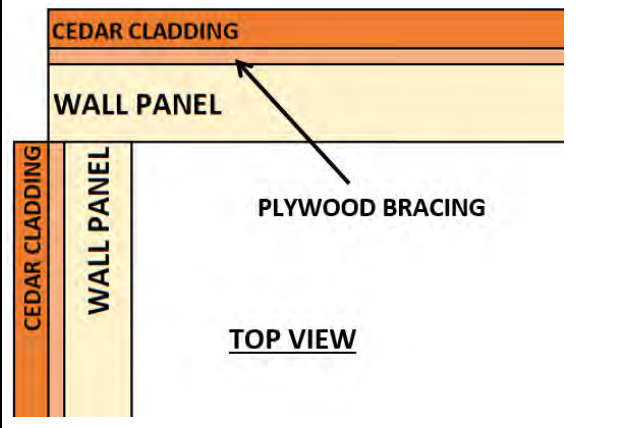

STEP 3.2

DOOR HEAD INSTALL

3.2 - ASSEMBLY PARTS – DOOR HEAD INSTALL		
PART CODE	QTY	DESCRIPTION
SDH	1	Single Door Head 840x123mm
DDH	1	Double Door Head 1440x123mm (DD option)
MP	2	Mending Plate
32PS	8	32mm Phillips Screw
100BS	2	100mm batten screw

- 3.2 - ASSEMBLY – DOOR HEAD INSTALL**
1. Mark 75mm either side on top of back side of door head (tongue is on top).
 2. Screw Mending Plate to top of back side of either side of Door Head using 2x 32PS.
 3. Place Door Head in position. Ensure back of Door Head sits flush with back frame of front panel and top of panel*.
 4. Predrill (with 4mm drill bit) and screw 1x 100BS through front panel into bottom of door head.
 5. Fasten Door Head by screwing 2x 32PS through mending plate into front panel. **Ensure Door Head sits hard against side of front panel.**
- * It helps to have one person to hold the door head while the other fastens it to the front panels.*

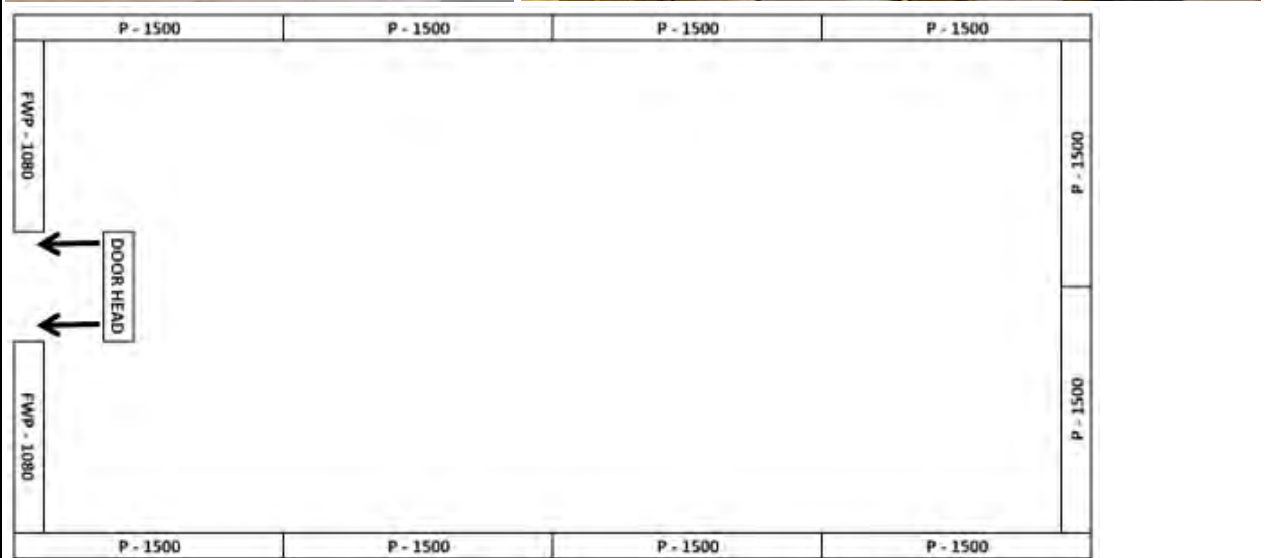

See next page for rest of door head install steps.



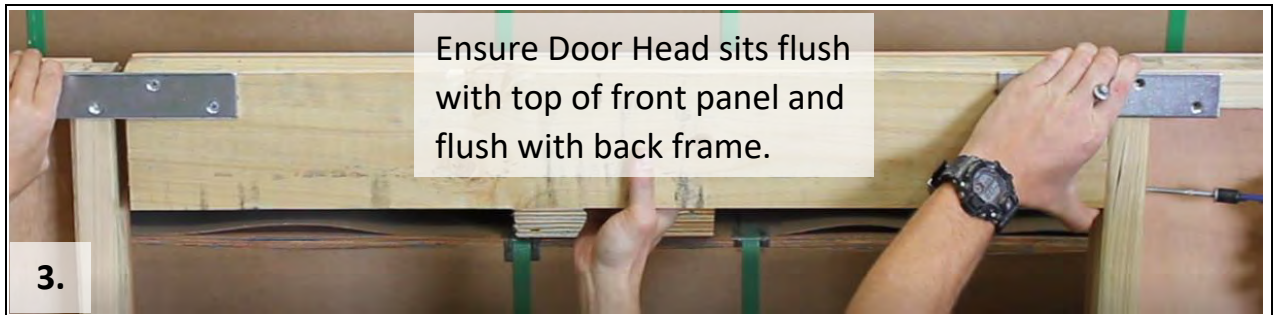

STEP 3.3

DOOR SURROUND INSTALL

3.3 - ASSEMBLY PARTS – DOOR SURROUND INSTALL		
PART CODE	QTY	DESCRIPTION
SDSS	1	Single Door Surround Set – 2@ 840mm, 2@ 1870mm
DDSS	1	Double Door Surround Set – 2@ 1440mm, 2@ 1870mm (DD option)
40N	20	40mm Nail
3.3 - ASSEMBLY – DOOR SURROUND INSTALL		
<ol style="list-style-type: none"> 1. Nail top 840mm (or 1440mm) Door Surround to bottom of door head (flush with back) using 4x 40N. 2. Nail bottom 840mm (or 1440mm) door surround to floor frame (hard against flooring) using 4x 40N*. Ensure wall panels are tight against surround (there should be an 840mm gap for SD and 1440mm gap for DD). 3. Measure and cut side 1870mm Door Surrounds to fit between top and bottom. 4. Nail side Door Surrounds, flush with back of wall panels, using 6x 40N per side. <p><i>* If floor frame was not purchased, secure bottom piece using silicone and concrete nails (not supplied).</i></p>		

Nail surround flush with back of frame using 40N.



STEP 3.4

BACK END GABLE ASSEMBLY

3.4 - ASSEMBLY PARTS – BACK END GABLE ASSEMBLY

PART CODE	QTY	DESCRIPTION
G	2	10ft Gable (left and right)
BGS	1	610mm Back Gable Cover Strip
65HHS	2	65mm Hex head screw
40N	5	40mm Nail

3.4 - ASSEMBLY – BACK END GABLE ASSEMBLY

Lay left and right gables (G) on a flat surface with the frame facing upwards, as seen below. Hold flush at the bottom and screw together in position shown below using 2x 65HHS.

Turn fastened gable over with the cedar now facing upwards. Position BGS over join in gable, holding bottom flush with bottom of cedar cladding and nail using 5x 40N.

** It is recommended to run a bead of silicone over the join before nailing SCS and FGS.*

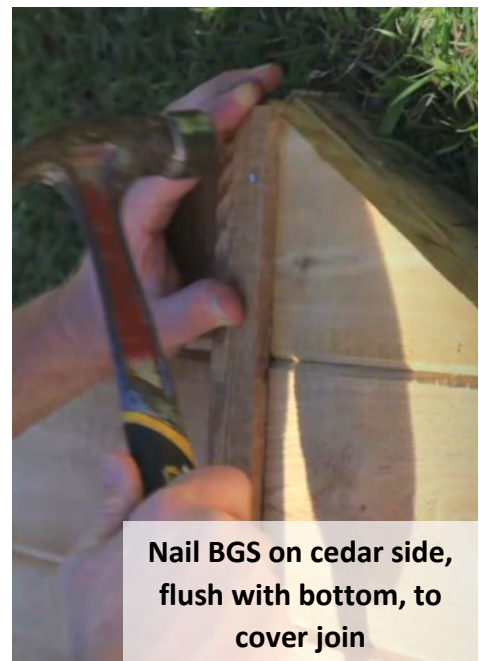
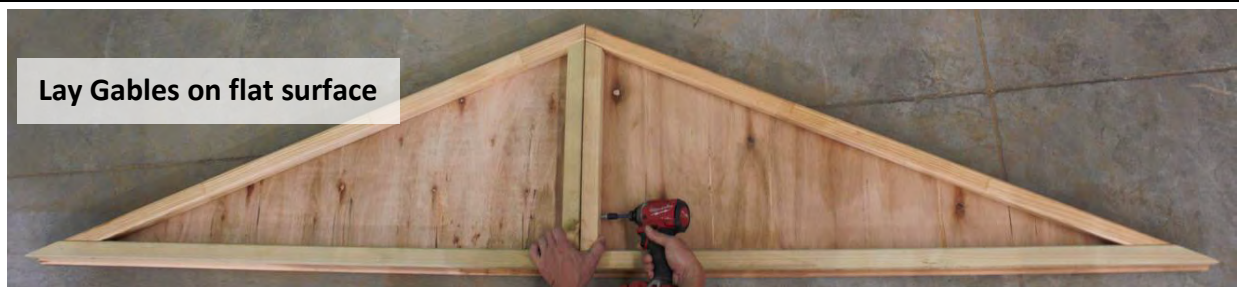

STEP 3.5

BACK END GABLE INSTALL

3.5 - ASSEMBLY PARTS – BACK END GABLE INSTALL

PART CODE	QTY	DESCRIPTION
	1	Assembled back end 10ft Gable
65HHS	6	65mm Hex head screw

3.5 - ASSEMBLY – BACK END GABLE INSTALL

Carefully place assembled gable on back wall, ensuring groove on gable slots into the tongue on the wall, as seen below. Ensure end of gable sits flush with side of back wall panel and fasten by screwing 6x 65HHS through panels into gable- 3 screws either side of join.

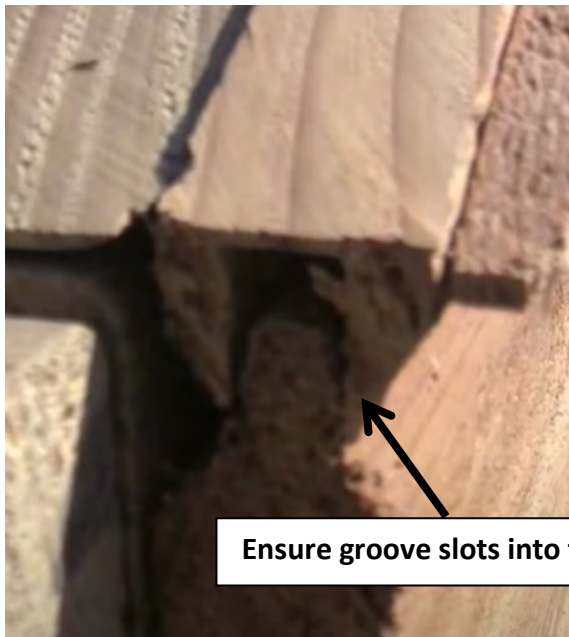

Ensure groove slots into tongue



Screw upwards through wall panel into gable



STEP 3.6

FRONT END GABLE ASSEMBLY

3.6 - ASSEMBLY PARTS – FRONT END GABLE ASSEMBLY

PART CODE	QTY	DESCRIPTION
G	2	10ft Gable (left and right)
SCS	1 & 1	Stilla Cover Strip (1@1800mm, 1@ 1200mm)
FGS	1	580mm Front Gable Cover Strip
65HHS	2	65mm Hex head screw
40N	15	40mm Nail

3.6 - ASSEMBLY – FRONT END GABLE ASSEMBLY

Lay left and right gables (G) on a flat surface with the frame facing upwards, as seen below. Hold flush at the bottom and screw together in position shown below using 2x 65HHS.

Turn fastened gable over with the cedar now facing upwards. Position SCS (1800 & 1200 pieces) flush at each end and flush with bottom of gable cedar cladding. Hold in place and using 10x 40N spaced evenly, nail to gable through cover strip. Position FGS over join in gable, holding bottom flush with top of SCS and nail using 5x 40N.

** It is recommended to run a bead of silicone over the join before nailing SCS and FGS.*

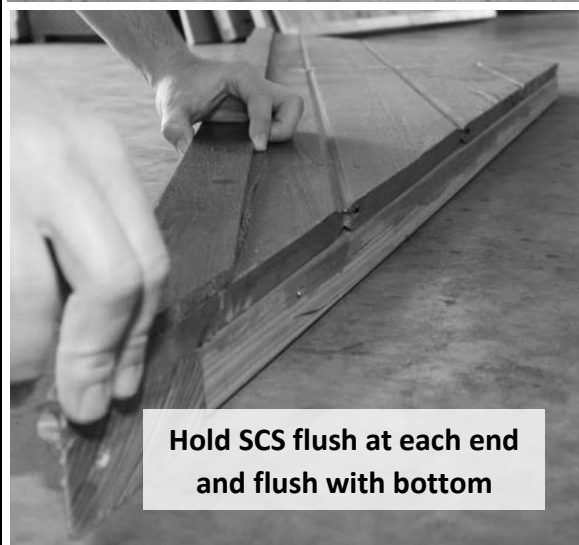

STEP 3.7

FRONT END GABLE INSTALL

3.7 - ASSEMBLY PARTS – FRONT END GABLE INSTALL

PART CODE	QTY	DESCRIPTION
	1	Assembled front end 10ft Gable
65HHS	6	65mm Hex head screw

3.7 - ASSEMBLY – FRONT END GABLE INSTALL

Carefully place assembled gable on front wall, ensuring groove on gable slots into the tongue on the wall, as seen below. Ensure end of gable sits flush with side of back wall panel and fasten by screwing 6x 65HHS through panels into gable- 3 screws either side of join.

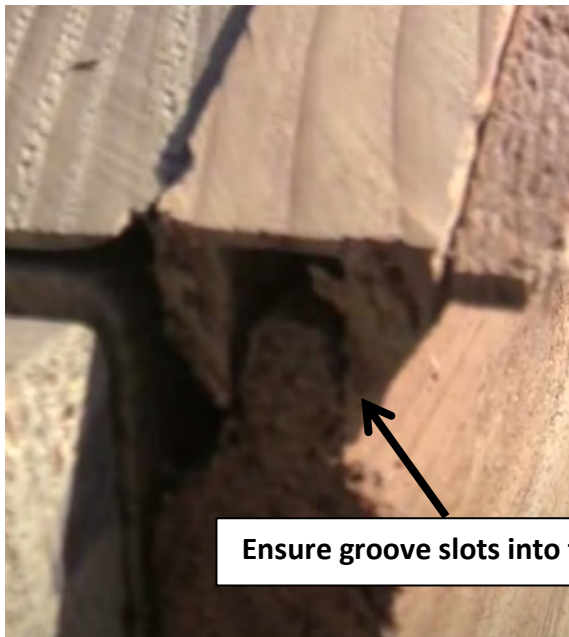

Ensure groove slots into tongue



Screw upwards through wall panel into gable



STEP 3.8

ROOF SUPPORT BLOCK INSTALL

3.8 - ASSEMBLY PARTS –ROOF SUPPORT BLOCK INSTALL

PART CODE	QTY	DESCRIPTION
RSB	2	Roof Support Block 250x70x45
75BS	4	75mm Batten Screw

3.8 - ASSEMBLY –ROOF SUPPORT BLOCK INSTALL

Place Roof Support Block flush with bottom of top gable frames as seen in photo below. Screw to gable frame using 2x 75BS per RSB*.

*** It is advised to predrill through the RSB using a 4mm drill bit, before screwing to gable.**

REPEAT THIS PROCESS ON BOTH GABLES.



STEP 4.0

ROOF FRAME ASSEMBLY

4.0 - ASSEMBLY PARTS – ROOF ASSEMBLY (REPEAT TWICE)		
PART CODE	QTY	DESCRIPTION
REP	4	Roof End Plate 1968x70x45mm
MREP	2	Middle Roof End Plate 1968x70x45mm
R	5	Roof Rafter 1520x70x45mm
JP	2	Joining Plate 1433x70x45mm
75BS	68	75mm Batten Screw

4.0 - ASSEMBLY – ROOF ASSEMBLY (1 of 2 frames)
It helps to find a flat, level surface to complete this process on.

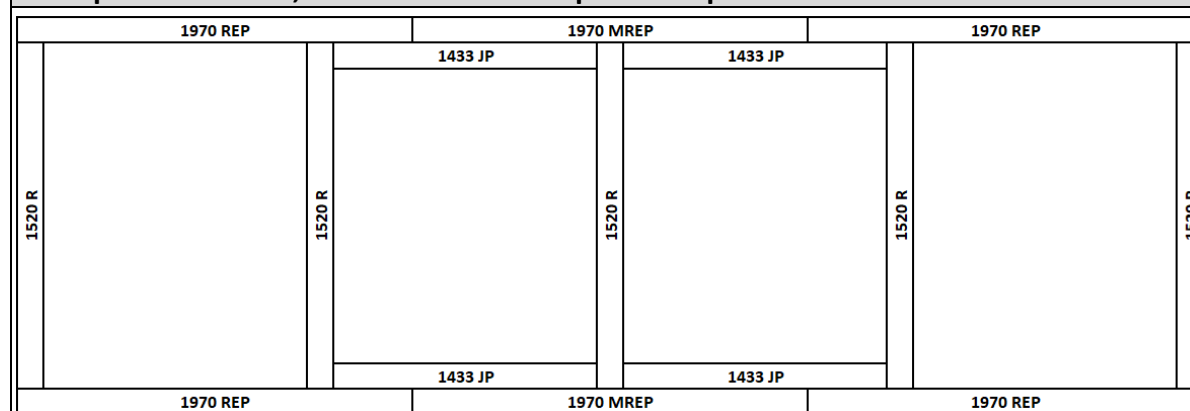

1. Position JP up to the 471mm line on REPs, hold flush and use predrilled holes to screw Roof End Plates (REP) to Middle Roof End Plate (MREP) with Joining Plate (JP) using 75BS (as pictured).



2. Place 5x Roof Rafters (R) in between joined REPs as seen in diagram above and screw 75BS into predrilled holes to finish assembling one roof frame.

REPEAT THIS ASSEMBLY PROCESS TWICE TO COMPLETE BOTH ROOF FRAMES - ENSURE FRAMES ARE SQUARED BEFORE MOVING ON



STEP 4.1

ROOF INSULATION INSTALL

If you did not purchase this option please skip this step

4.1 - ASSEMBLY PARTS – ROOF INSULATION INSTALL (REPEAT TWICE)		
PART CODE	QTY	DESCRIPTION
RI (option)	5	Roof Insulation 1600x1300mm
40N	50	40mm Nails

4.1 - ASSEMBLY – ROOF INSULATION INSTALL (REPEAT WITH SECOND FRAME)

It helps to find a flat, level surface to complete this process on.

Once roof frame is assembled, fix Roof Insulation to top of frame before screwing roof sheets over top.

Fix Roof Insulation to top of frame using bent 40N (or staples- not supplied).

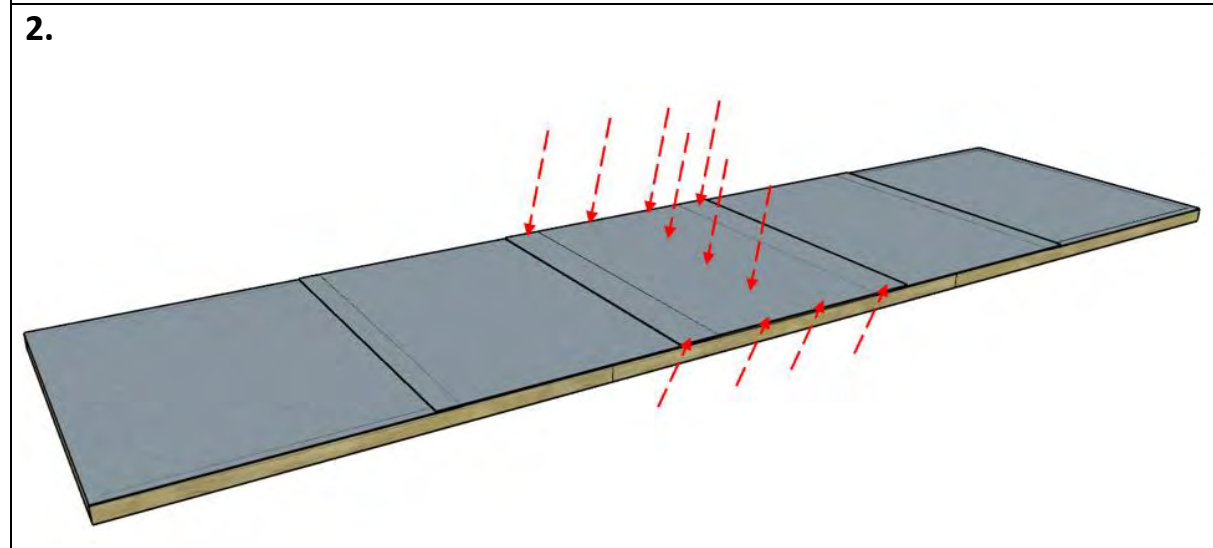
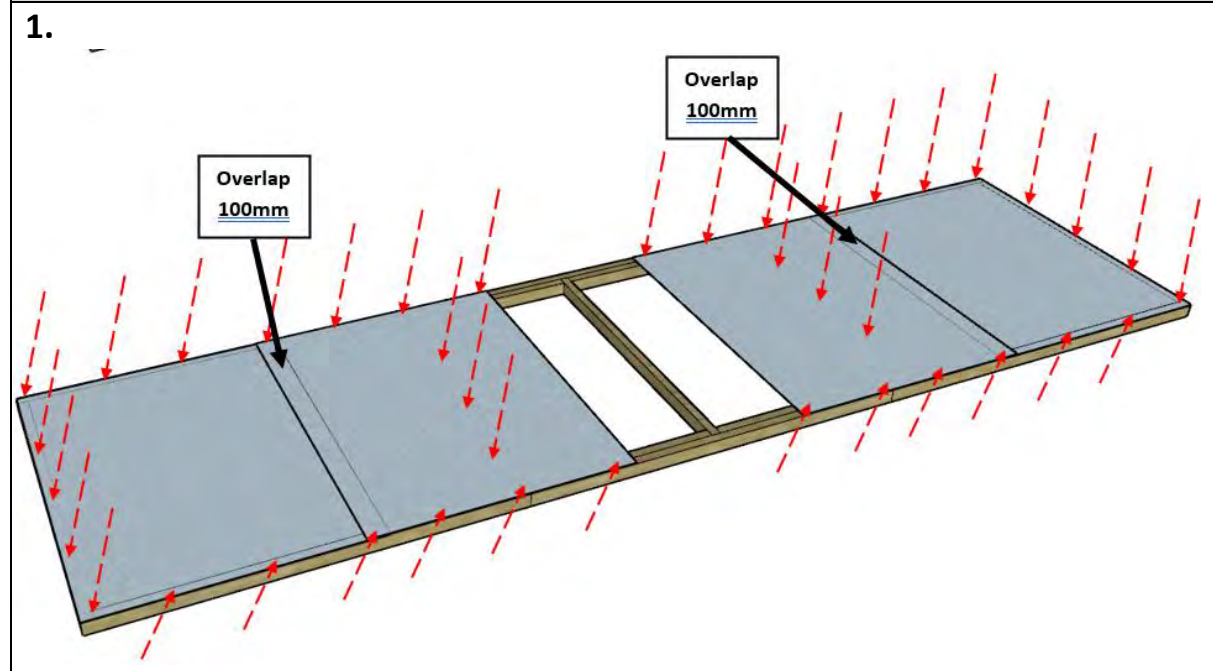

STEP 4.2

ROOF ASSEMBLY

4.2 - ASSEMBLY PARTS – ROOF ASSEMBLY (ROOF SHEETS)		
PART CODE	QTY	DESCRIPTION
RS	2	1800mm roof sheet
40RS	2	40mm Roof screw
25RS	2	25mm Roof screw

4.2 - ASSEMBLY – ROOF ASSEMBLY (ROOF SHEETS)

It helps to find a flat, level surface to complete this process on.

Position roof sheets (RS) at either end of roof frame and fasten in place as indicated in diagrams. Lay roof sheet (bent edge) flush with top of roof frame while hanging side of roof sheet **203mm*** over end of roof frame. Once in position, screw 25RS through pan at top** FIRST and then (checking bottom is still overhanging 203mm from side) screw a 40RS through rib at the bottom** to fasten roof sheet in place.

** Use 203mm “E” or tape measure when placing overhanging side of roof sheet (ENSURE ROOF SHEET RUNS PARRELEL TO ROOF FRAME END).*

*** Only screw 25RS in pan at the top and 40RS in the bottom of roof sheet.*

Hang side of roof sheet, 203MM over end of roof frame (TOP) **Bent up edge at top**

(SIDE VIEW)

(END VIEW)

Flush → **1800 RS** **1520 R**

REPEAT THIS STEP FOR SECOND ROOF FRAME



STEP 4.3

ROOF ASSEMBLY

4.3 - ASSEMBLY PARTS – ROOF ASSEMBLY (ROOF SHEETS)		
PART CODE	QTY	DESCRIPTION
RS	6	1800mm roof sheet
RS	1	1800mm Double Pan roof sheet
40RS	8	40mm Roof screw
25RS	16	25mm Roof screw

4.3 - ASSEMBLY – ROOF ASSEMBLY (ROOF SHEETS)

Complete laying roof sheeting out on frame. Fasten roof sheets to battens in sequence shown. 1 x 25RS either side of join at top and 1 x 40RS through rib join at bottom.

Note: Use straight edge to keep all screws in line and centre of batten.

REPEAT THIS STEP FOR SECOND ROOF FRAME



STEP 4.4

ROOF ASSEMBLY

4.4 - ASSEMBLY PARTS – ROOF ASSEMBLY		
PART CODE	QTY	DESCRIPTION
40RS	29	40mm Roof screw
25RS	31	25mm Roof screw

4.4 - ASSEMBLY – ROOF ASSEMBLY	
Complete screwing roof off at top. 1 x 25RS in pan beside every rib. Once top is complete screw bottom off using 1 x 40RS through every rib. <i>Note: Use straight edge to keep all screws in line and centre of batten.</i>	
REPEAT THIS STEP FOR SECOND ROOF FRAME	



STEP 4.5

CHANNEL ASSEMBLY

If you purchased the Annex, leave the channel off the side you will be installing your Annex

4.5 - ASSEMBLY PARTS – CHANNEL ASSEMBLY		
PART CODE	QTY	DESCRIPTION
ST	13	12mm self-tapping screw
C	4	Roof Channel

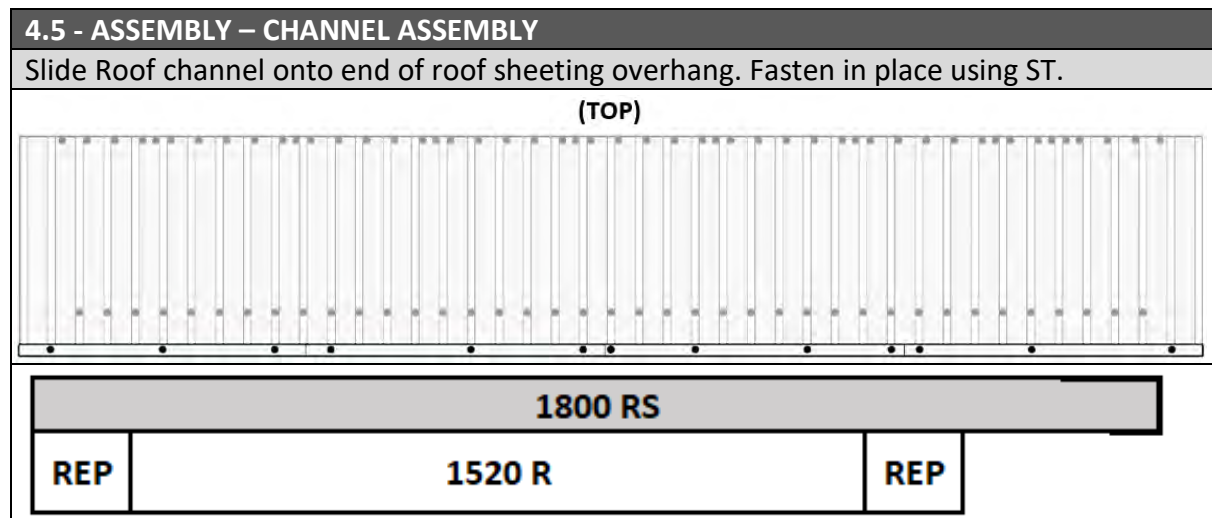

REPEAT TASKS 4.0 – 4.5 TO COMPLETE THE OTHER ROOF PANEL.

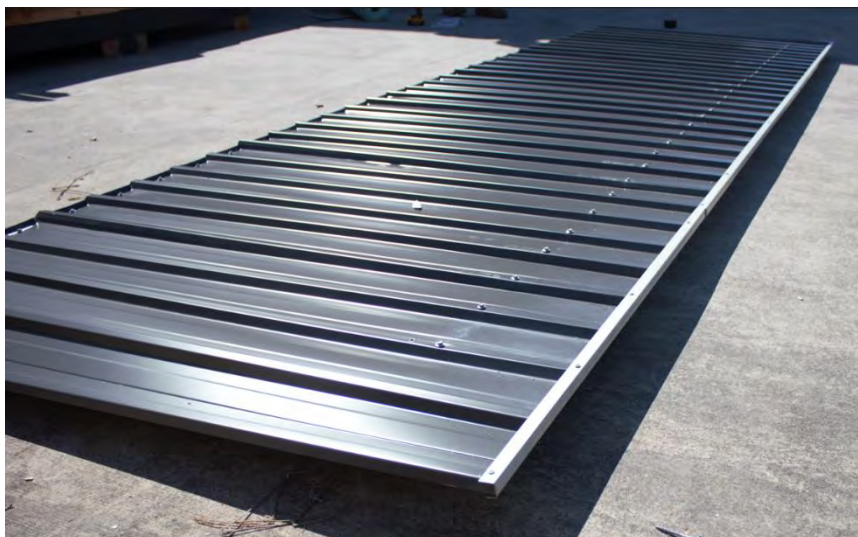

STEP 4.6

ROOF END PIECE

4.6 - ASSEMBLY PARTS – RIDGE BEAM BRACKET

PART CODE	QTY	DESCRIPTION
E	12	Roof End Piece 203x70x30mm
65BS	12	65 Batten Screws

4.6 - ASSEMBLY – ROOF END PIECES TO GABLES

Standing inside shed on ladder, screw roof end pieces to top of gable in required positions using 1x 65BS per piece. See positions in photo below. Lay 70mm side flat on top of gable with 70x30mm face flush with inside of gable frame and screw in place (6 pieces per gable).

Note: It is advised to predrill through the E first with a 4mm drill bit, before securing to gable.

Repeat this step on both gables.

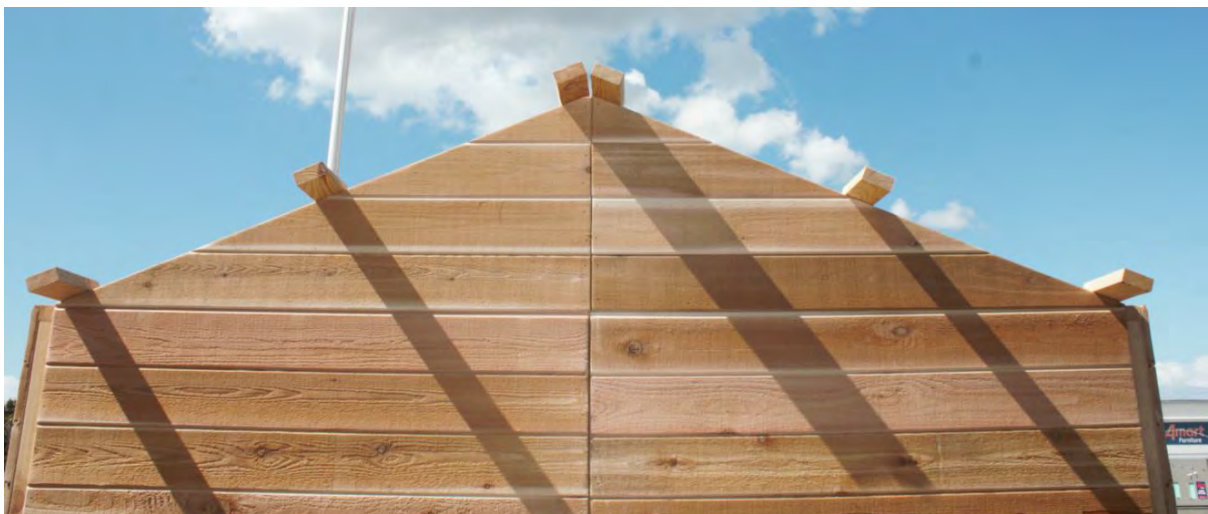

STEP 4.7

ROOF INSTALLATION

4.7 - ASSEMBLY PARTS – ROOF INSTALLATION

PART CODE	QTY	DESCRIPTION
	2	Completed roof panels
75BS	20	75mm Batten Screw
125BS	8	125mm Batten Screw

4.7 - ASSEMBLY – ROOF INSTALLATION

Slide roof frame into position. Ensure point of roof frame is flush with middle of gable as seen below. Fasten to ends using 3x 75BS, screw through roof frame into gable frame. Fasten to sides using 4x 75BS evenly spaced, screw through roof frame into side wall top plates, use 4x 125BS for middle of side, through JPs. Meet second roof frame up with the first and repeat steps for fastening.

This task will require 4 or more persons to complete.



STEP 4.8

ROOF INSTALATION

4.8 - ASSEMBLY – ROOF INSTALLATION

PART CODE	QTY	DESCRIPTION
40RS	8	40mm Roof Screws
25RS	8	25mm Roof Screws

4.8 – ASSEMBLY – ROOF INSTALLATION

Fully fasten down the roof sheeting onto the Roof End Pieces (E) as seen below. Use 2x 25RS to screw into the top E of each side and 2x 40RS to screw into the bottom E of each side.

Note: there is four sides.



STEP 4.9

COLLAR TIE INSTALLATION

4.9- ASSEMBLY PARTS – COLLAR TIE INSTALLATION

PART CODE	QTY	DESCRIPTION
LCT	2	Large Collar tie
40RS	20	40mm Roof Screw
125BS	16	125mm Batten Screw

4.9 - ASSEMBLY – COLLAR TIE INSTALLATION

Holding Collar tie tight and level in position screw through CT into Roof Rafters in predrilled holes, using 6x 40RS per collar tie.
Fasten roof frames together by screwing 125BS evenly space along the top of the roof frames.



If Double door option was chosen, please go to step 5.4

STEP 5.0

SINGLE DOOR HINGE ASSEMBLY

5.0 - ASSEMBLY PARTS – SINGLE DOOR HINGE ASSEMBLY		
PART CODE	QTY	DESCRIPTION
BH	3	Butt Hinge
HS	12	Hinge Screw
SCD	1	Single Colonial Door

5.0 - ASSEMBLY – SINGLE DOOR HINGE ASSEMBLY

1. Place door on side and measure out hinge positions as seen below.
2. **Ensure hinge join sits on outside of door/studio and the edge sits flush with edge of door as seen below.**
3. Place hinges in required positions and screw to side using 4x HS*.

* 3mm *Pre-drill is recommended before fastening hinges to door.*

Place hinges 100mm from top and bottom and centre of door (893mm mark), as seen below.

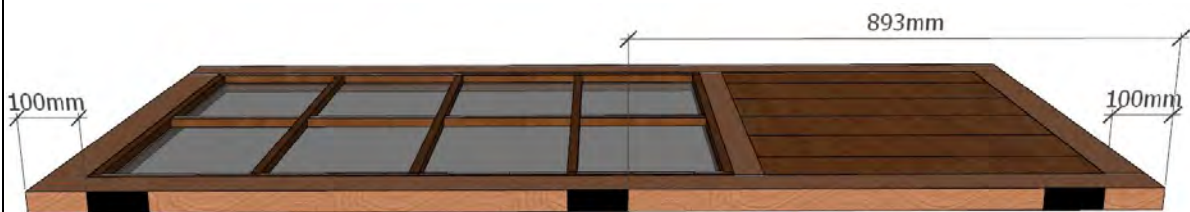

Ensure Butt sits on exterior side of door.

Screw hinge once edge is flush with interior of door



STEP 5.1

SINGLE DOOR INSTALLATION

5.1 - ASSEMBLY PARTS – SINGLE DOOR INSTALLATION

PART CODE	QTY	DESCRIPTION
SCD	1	Single Colonial Door
HS	12	Hinge screw

5.1 - ASSEMBLY – SINGLE DOOR INSTALLATION

Mark top door hinge placement on side panel, 105mm from bottom of door head. (so door sits 5mm down from top).

Holding the door in position, parallel to shed*, attach door by screwing 6x HS per hinge into side panel frame**. ***This is easier with two people, one to hold the door in place and another to attach the door.***

* Front of door should be facing shed panels.

** It is recommended to only screw one HS in the top and bottom hinge and check the door is in the right position before screwing all (door should sit 5mm down from top).



STEP 5.2

DOOR HANDLE ASSEMBLY

5.2 - ASSEMBLY PARTS – DOOR HANDLE ASSEMBLY

PART CODE	QTY	DESCRIPTION
TH	1	T Handle

5.2 - ASSEMBLY – DOOR HANDLE ASSEMBLY

1. Find suitable height for T Handle (generally 1050mm up door).
2. Mark and drill 12mm centre hole in position, 40mm in from door edge.
3. Insert T handle in position and mark two outside holes.
4. Remove T handle and drill 2 x 6mm holes.
5. Insert T handle back in with bolts and fasten nuts on back of door.



Mark and drill 12mm centre hole- 40mm in, 1050mm up.



Insert T-handle



Mark 6mm side holes



Drill 6mm holes and fasten t-handle to door with bolts, nuts, and washers.



STEP 5.3

DOOR HANDLE ASSEMBLY

5.3 - ASSEMBLY PARTS – DOOR HANDLE ASSEMBLY

PART CODE	QTY	DESCRIPTION
DL	1	D-Handle Lever

5.3 - ASSEMBLY – DOOR HANDLE ASSEMBLY

Holding door in closed position, flush with VJ cladding on front - slide lever onto T Handle and tighten using a 4mm allen key once hitting on wall stud beside door.



If Double door option was not chosen please go to step 6.0

STEP 5.4

DOUBLE DOOR HINGE ASSEMBLY

5.4 - ASSEMBLY PARTS – DOUBLE DOOR HINGE ASSEMBLY		
PART CODE	QTY	DESCRIPTION
BH	6	Butt Hinge
HS	24	Hinge Screw
DCD	2	Double Colonial Door



5.4 - ASSEMBLY – DOUBLE DOOR HINGE ASSEMBLY

1. Place door on side and measure out hinge positions as seen below.
2. **Ensure hinge join sits on outside of door/studio and the edge sits flush with edge of door as seen below.**
3. Place hinges in required positions and screw to side using 4x HS*.

** 3mm Pre-drill is recommended before fastening hinges to door.*

Repeat step with second door.

Place hinges 100mm from top and bottom and centre of door (893mm mark), as seen below.

Ensure Butt sits on exterior side of door.



Screw hinge once edge is flush with interior of door



STEP 5.5

DOUBLE DOOR INSTALLATION

5.5 - ASSEMBLY PARTS – DOUBLE DOOR INSTALLATION

PART CODE	QTY	DESCRIPTION
DCD	2	Double Colonial Doors
HS	24	Hinge screw

5.5 - ASSEMBLY – DOUBLE DOOR INSTALLATION

Mark top door hinge placement on side panel, 105mm from bottom of door head. (so door sits 5mm down from top).

Holding the door in position, parallel to shed*, attach door by screwing 6x HS per hinge into side panel frame**. ***This is easier with two people, one to hold the door in place and another to attach the door.***

* Front of door should be facing shed panels.

** It is recommended to only screw one HS in the top and bottom hinge and check the door is in the right position before screwing all (door should sit 5mm down from top).



STEP 5.6

DOUBLE DOOR SEAL INSTALLATION

5.6 - ASSEMBLY PARTS – DOUBLE DOOR SEAL INSTALLATION

PART CODE	QTY	DESCRIPTION
DDS	1	Double Door Vertical Seal – 1855x55x20mm
40N	8	40mm Nail

5.6 - ASSEMBLY – DOUBLE DOOR SEAL INSTALLATION

Choose fixed door (generally left hand door). Position flat side of DDS 15mm down from top of door and 40mm in from side and nail to back of fixed door using 8x 40N (as seen below).



STEP 5.7

BARREL BOLT INSTALL

5.7 – ASSEMBLY PARTS – BARREL BOLT INSTALL

PART CODE	QTY	DESCRIPTION
BB	2	Barrel Bolt
BBS	8	Barrel Bolt Screw

5.7 - ASSEMBLY – BARREL BOLT INSTALL

Hold Barrel Bolt in position, hard against Door Seal, and fasten to door using 4x BBS per Barrel Bolt (as seen below). Hold door in closed position, mark centre of bolt and drill 9mm hole. Repeat for bottom barrel bolt.

Note- T-Handle must be installed on the opposite door to the fixed door (door with barrel bolts).

Fasten Barrel Bolt to door.



Mark centre of bolt.



Drill 9mm hole.



STEP 5.8

DOOR HANDLE ASSEMBLY

5.8 - ASSEMBLY PARTS – DOOR HANDLE ASSEMBLY

PART CODE	QTY	DESCRIPTION
TH	1	T Handle

5.8 - ASSEMBLY – DOOR HANDLE ASSEMBLY

1. Find suitable height for T Handle (generally 1050mm up door).
2. Mark and drill 12mm centre hole in position, 40mm in from door edge.
3. Insert T handle in position and mark two outside holes.
4. Remove T handle and drill 2 x 6mm holes.
5. Insert T handle back in with bolts and fasten nuts on back of door.



Mark and drill 12mm centre hole- 40mm in, 1050mm up.



Insert T-handle



Mark 6mm side holes



Drill 6mm holes and fasten t-handle to door with bolts, nuts, and washers.



STEP 5.9

DOOR HANDLE ASSEMBLY

5.9 - ASSEMBLY PARTS – DOOR HANDLE ASSEMBLY

PART CODE	QTY	DESCRIPTION
DL	1	D-Handle Leaver

5.9 - ASSEMBLY – DOOR HANDLE ASSEMBLY

Holding door in closed position, flush with other door - slide leaver onto T Handle and tighten using a 4mm allen key once hitting Seal on fixed door.



STEP 6.0

WINDOW ASSEMBLY INSTALLATION

6.0 - ASSEMBLY PARTS – WINDOW ASSEMBLY INSTALLATION

PART CODE	QTY	DESCRIPTION
SWA	2	Studio Window Assembly
32PS	40	32mm Phillips screw

6.0 - ASSEMBLY – WINDOW ASSEMBLY INSTALLATION

Fit Window Assembly into hole in Window Panel*. Ensuring the window frame is square, fasten to Window Panel by screwing through perimeter of Window Panel hole into SWA**. Use 4x 32PS in top and bottom of SWA and 6x 32PS for sides.

* Ensure window opens the side that suits you, flip Window Assembly to change.

** It is advised to predrill using a 3mm drill bit before screwing.

Repeat process for second window and any additional windows.



STEP 6.1

INTERNAL WINDOW STRIP ASSEMBLY

6.1 - ASSEMBLY PARTS – INTERNAL WINDOW STRIP ASSEMBLY		
PART CODE	QTY	DESCRIPTION
SIWS	2	Studio Internal Window Strip Set- 2@ 770mm, 2@ 1240mm
40N	40	40mm Nail

6.1 - ASSEMBLY – INTERNAL WINDOW STRIP ASSEMBLY

1. Measure 25mm around perimeter of Window Panel hole.
2. Position and nail top 770mm strip using 4x 40N.
3. Position and Nail left side 1240mm strip using 6x 40N.
4. Position and Nail right side 1240mm strip and bottom 770mm strip together using 6x 40N for side and 4x 40N for bottom (adjust to line up).

Repeat process for second window and any additional windows.

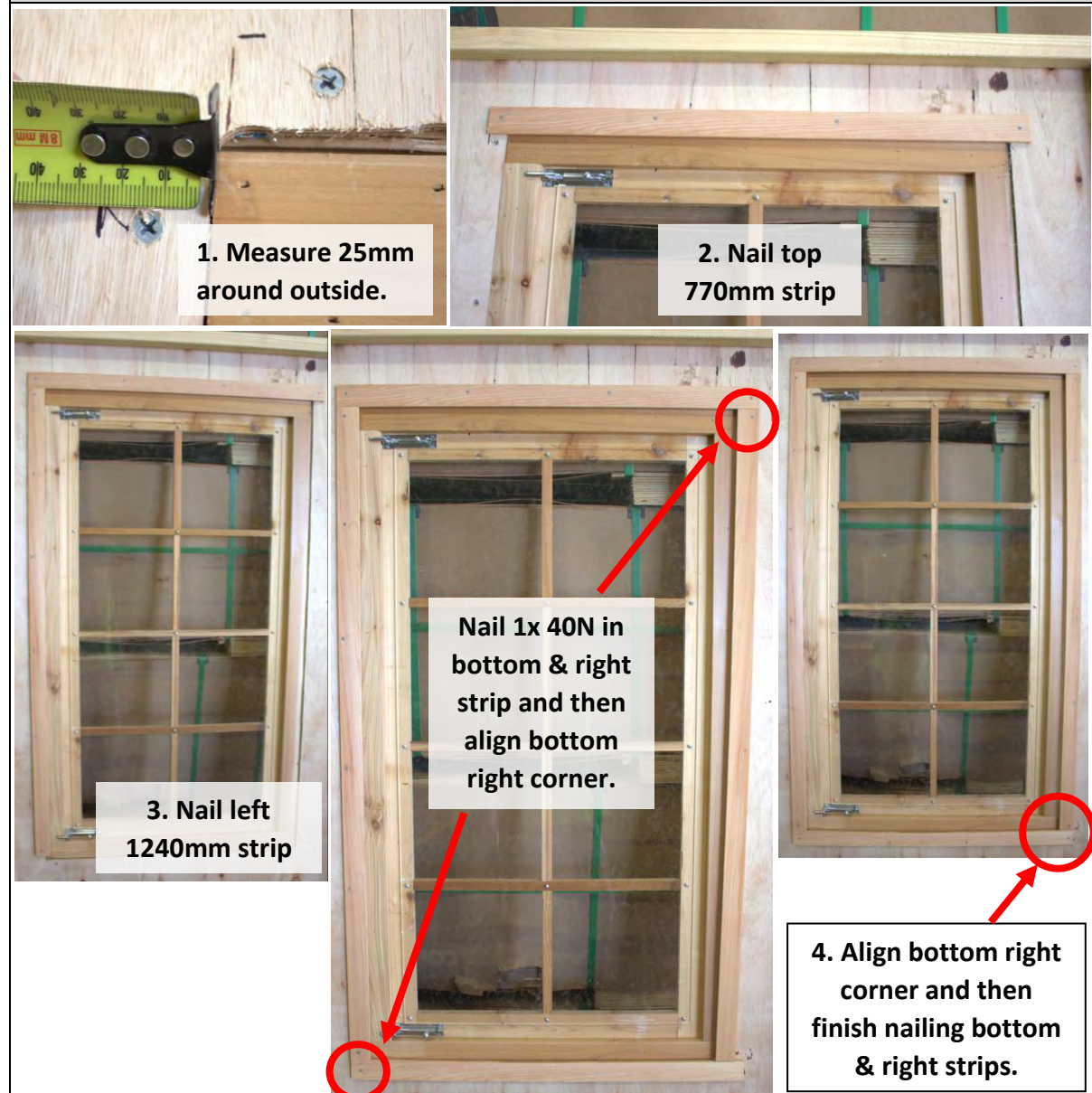

STEP 6.2

CORNER POST ASSEMBLY

6.2 - ASSEMBLY PARTS – CORNER POST ASSEMBLY		
PART CODE	QTY	DESCRIPTION
CP	4	2015mm Corner Post
40N	24	40mm Nail

6.2 - ASSEMBLY – CORNER POST ASSEMBLY
 Hold corner post (CP) in position, nail through CP into wall stud using 6x 40N evenly spaced along CP. Repeat for all four corners.
Note: Before nailing CPs, we recommend running a bead of silicone down the lines seen below.

Recommended: Run a bead of silicone down these two lines before nailing CPs



Nail 6x 40N evenly spaced along CP



STEP 6.3

COVER STRIP ASSEMBLY

6.3 - ASSEMBLY PARTS – COVER STRIP ASSEMBLY

PART CODE	QTY	DESCRIPTION
CP	9	2015mm Cover Strip
40N	54	40mm Nail

6.3 - ASSEMBLY – COVER STRIP ASSEMBLY

Hold cover strips (CS) over joins in walls and beside door/s, nail through CS into wall panel using 6x 40N evenly spaced per CS.

Note: Before nailing CS, we recommend running a bead of silicone down the joins in the wall, as seen below.

Recommended: Run a bead of silicone down joins before nailing CS



Nail 6x 40N evenly spaced along CP



STEP 6.4

FASCIA ASSEMBLY

6.4 - ASSEMBLY PARTS – FASCIA ASSEMBLY		
PART CODE	QTY	DESCRIPTION
SF	4	10ft Studio Fascias – 140x20
40N	24	40mm Nail
6.4 - ASSEMBLY – FASCIA ASSEMBLY		
Hold fascias in position, parallel with Ends and join evenly at top. Nail 2x 40N through fascia into End pieces to fasten.		
		

STEP 6.5

RIDGE CAP INSTALLATION

6.5 - ASSEMBLY PARTS – RIDGE CAP INSTALLATION		
PART CODE	QTY	DESCRIPTION
RC	3	Ridge Cap
40RS	18	40mm Roof screw
6.5 - ASSEMBLY – RIDGE CAP INSTALLATION		
Slide ridge cap into position. Make sure peak of ridge cap is in line with peak of fascia's. Screw through ridge cap into 2 nd rib in from end and through into batten. Slide second and third ridge cap into position and fasten in position, repeat with 3 rd ridge cap. Ensure ridge cap is straight and fasten through the centre overlaps, on both sides.		
		



STEP 6.6

EXTERNAL FIXED WINDOW STRIP ASSEMBLY

If you did not purchase a fixed window panel, please skip this step.

6.6 - ASSEMBLY PARTS – COVER STRIP ASSEMBLY

PART CODE	QTY	DESCRIPTION
CS	4	2015mm Cover Strip (per fixed window)
40N	20	40mm Nail (per fixed window)

6.6 - ASSEMBLY – COVER STRIP ASSEMBLY

Mark 3mm around perimeter of window. Mark and cut side strips to size. Nail Side strips using 6x 40N per side. Mark and cut top and bottom strips to size. Nail top and bottom strips using 4x 40N per.

Note: Before nailing CS, we recommend running a bead of silicone down the joins in the wall, as seen below.



STEP 6.7

6.7 - ASSEMBLY PARTS – FIXING TO BASE

PART CODE	QTY	DESCRIPTION
65HHS	22	65mm Hex Head Screw

6.7 - ASSEMBLY – FIXING TO BASE

Once shed is in desired position and doors are sitting evenly you can now fix your shed to the base. Fix either side of door, at each corner and at each join of panel. It is recommended that fixings are every 1200mm. Fasten down through bottom plate using 65HHS.

Note: Fasteners are not supplied if going on a concrete slab– 100mm Dyna bolts are recommended.

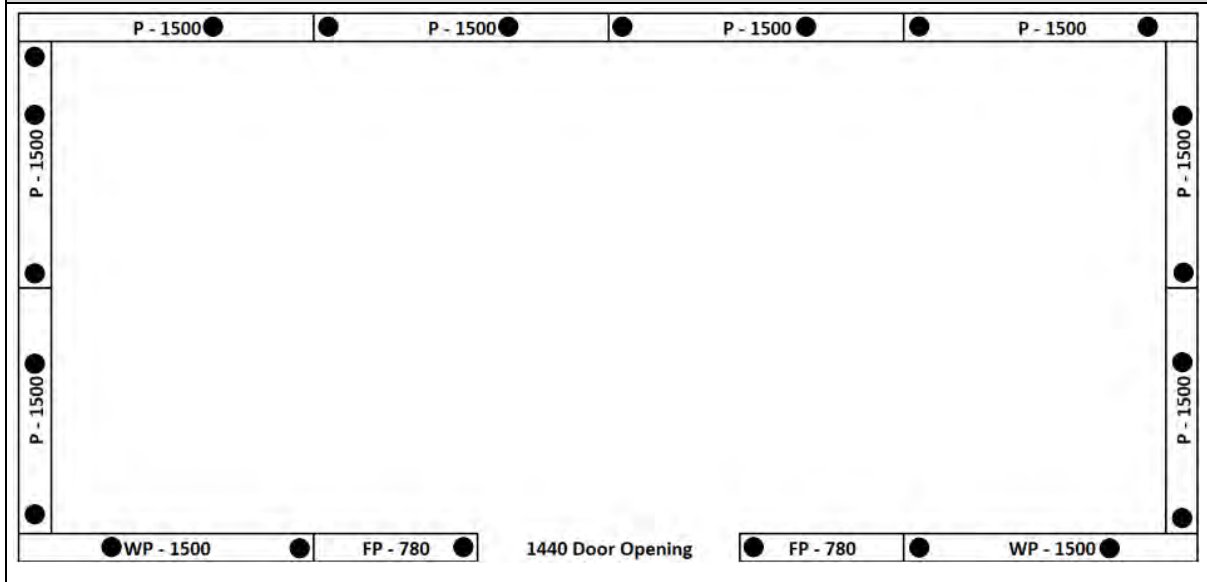

STEP 7.0

ANNEX FRAME ASSEMBLY

If you did not purchase this option please skip this step

7.0 - ASSEMBLY PARTS – ANNEX FRAME		
PART CODE	QTY	DESCRIPTION
VB	2	Veranda Beam 3160x70x45mm
VBJ	1	Veranda Beam Joiner 700x70x45mm
VOB	2	Veranda Outer Beam 3160x140x35mm
VOBJ	1	Veranda Outer Beam Joiner 700x140x35mm
VR	6	Veranda Rafter 1320x70x45mm
65BS	14	65mm Batten Screw
100BS	12	100mm Batten Screw

7.0 - ASSEMBLY – ANNEX FRAME

It helps to find a flat, level surface to complete this process on.

1. Join Veranda Beams (VB) together using Veranda Beam Joiner (VBJ). Mark 350mm (middle) on VBJ and Butt Veranda Beams into each other, hold flush and fasten together using 3x 65BS each through VBJ into VB, as seen below.

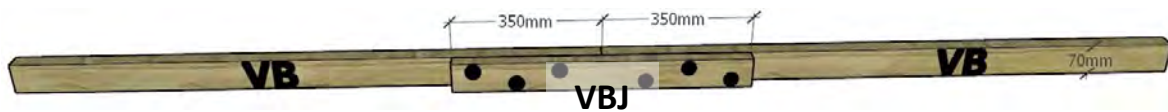

2. Join Veranda Outer Beams (VOB) together using Veranda Outer Beam Joiner (VOBJ). Mark 350mm (middle) on VOBJ and Butt Veranda Outer Beams into each other, hold flush and fasten together using 4x 65BS each through VOBJ into VOB, as seen below.

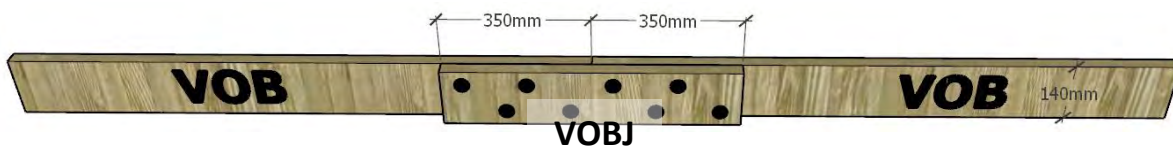

3. Assemble veranda frame. Place 6x Veranda Rafters (VR) in between joined VB and VOB, as seen below. Hold VR 70mm side flush with top and screw through beams, using 1x 100BS per join. **It is advised to predrill through beams before screwing rafters.**

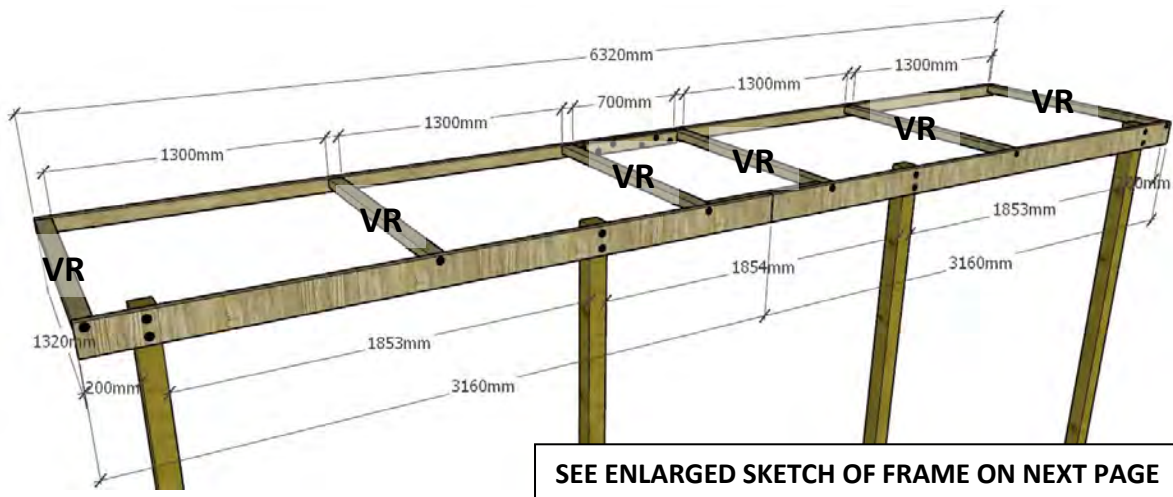

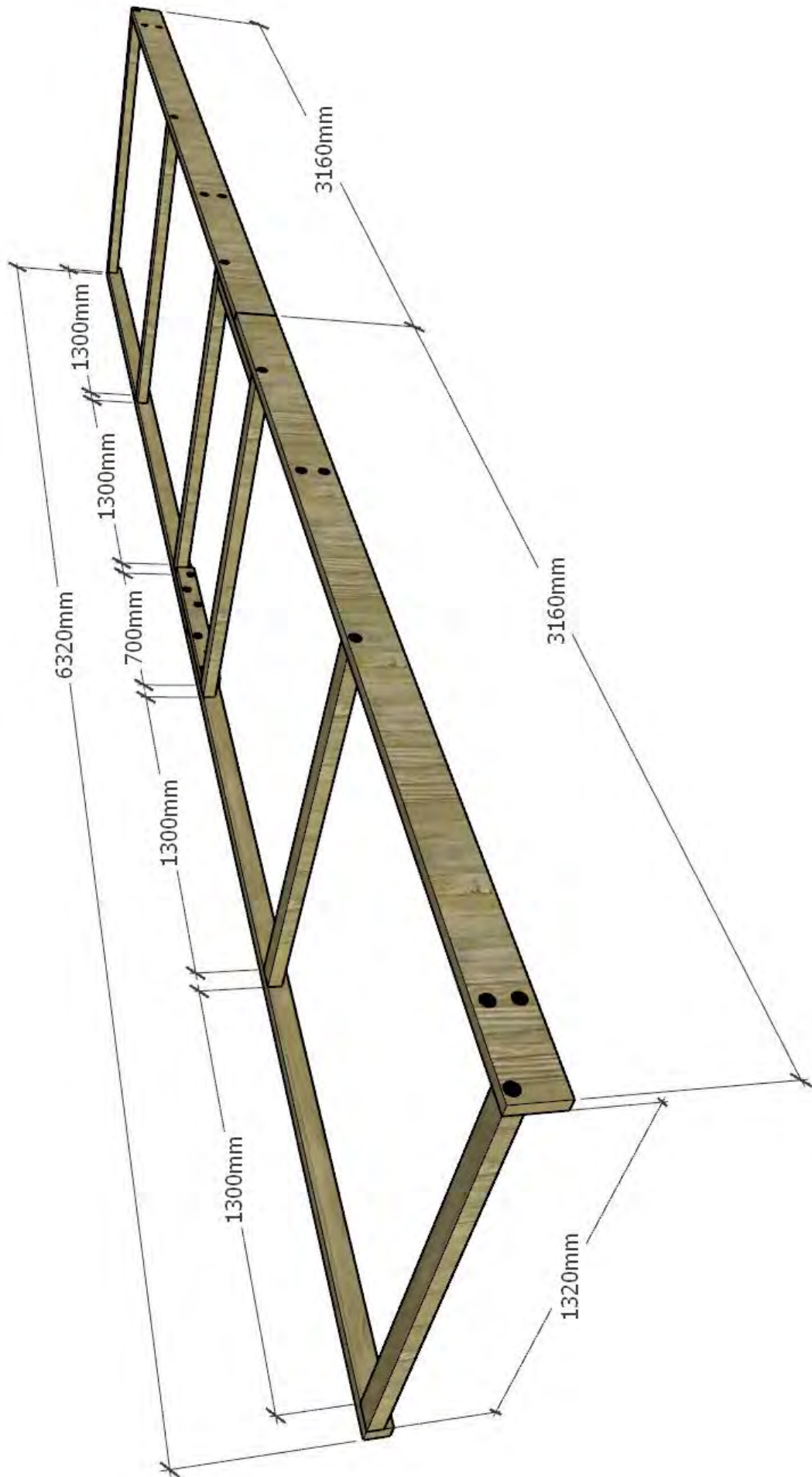

STEP 7.1

ANNEX ROOF

7.1 - ASSEMBLY PARTS – ANNEX ROOF		
PART CODE	QTY	DESCRIPTION
VRS	2	1450mm Veranda Roof Sheet
40RS	2	40mm roof screw
25RS	2	25mm roof screw

7.1 - ASSEMBLY – ANNEX ROOF	
Place assembled veranda on a flat, level surface to fasten roofing.	
<p>Position veranda roof sheets (VRS) at either end of roof frame and fasten in place as indicated in diagrams. Lay roof sheet (bent edge) flush with top of veranda frame with side of roof sheet sitting flush with end of veranda frame. Once in position, screw 25RS through pan at top* FIRST and then screw a 40RS through rib at the bottom* to fasten roof sheet in place.</p>	
<p><i>*Only screw 25RS in pan at the top and 40RS in the bottom of roof sheet.</i></p>	
<p>The diagram illustrates the assembly of the annex roof. It shows a central veranda frame with components labeled VB, VBJ, VR, and VOB. Two roof sheets (VRS) are attached to the ends. The left sheet is positioned flush with the end of the veranda frame and the VB component. The right sheet has its top edge bent up. Screws 25RS are shown at the top of the sheets, and 40RS are shown at the bottom. An arrow points to the 'Overhang' area below the frame.</p>	



STEP 7.2

ANNEX ROOF

7.2 - ASSEMBLY PARTS – ANNEX ROOF		
PART CODE	QTY	DESCRIPTION
VRS	7	1450mm veranda roof sheet
40RS	8	40mm Roof screw
25RS	16	25mm Roof screw

7.2 - ASSEMBLY – ANNEX ROOF

Complete laying roof sheeting out on frame. Fasten roof sheets to beams in sequence shown. 1 x 25RS either side of join at top and 1 x 40RS through rib join at bottom.

Note: Use straight edge to keep all screws in line and centre of beam.

The diagram illustrates the assembly of roof sheeting on a frame. It shows a series of 23 numbered screws (1-23) and 6 joints (labeled 'Join'). The screws are arranged in two rows: the top row contains screws 1-12 and 14-15, while the bottom row contains screws 17-23. The joints are located between screws 1-2, 3-4, 5-6, 7-8, 9-10, and 11-12. Annotations include:

- 'Keep roof sheets flush with top of roof frame' pointing to the top edge of the sheeting.
- 'Bent up edge at top' pointing to the top edge of the sheeting between screws 7 and 8.
- 'Overlap Pans here' pointing to the overlap between screws 13 and 14.
- '25RS' and '40RS' labels indicating the placement of 25mm and 40mm roof screws respectively.
- A central instruction: 'PLACE ALL ROOF SHEETS DOWN FIRST BEFORE SCREWING'.



STEP 7.3

ANNEX ROOF

7.3 - ASSEMBLY PARTS – ANNEX ROOF		
PART CODE	QTY	DESCRIPTION
40RS	33	40mm Roof screw
25RS	33	25mm Roof screw

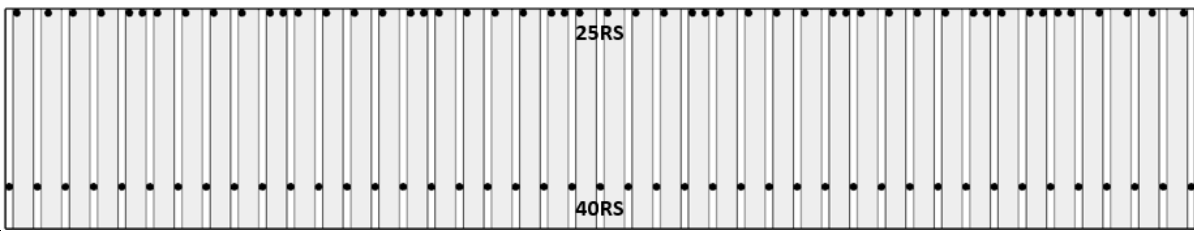
7.3 - ASSEMBLY – ANNEX ROOF
<p>Complete screwing roof off at top. 1 x 25RS in pan beside every rib. Once top is complete screw bottom off using 1 x 40RS through every rib.</p> <p><i>Note: Use straight edge to keep all screws in line and centre of batten.</i></p>

STEP 7.4

ANNEX ROOF CHANNEL

TURN BACK TO PAGE 28, STEP 4.4, TO FASTEN CHANNEL TO ANNEX ROOF



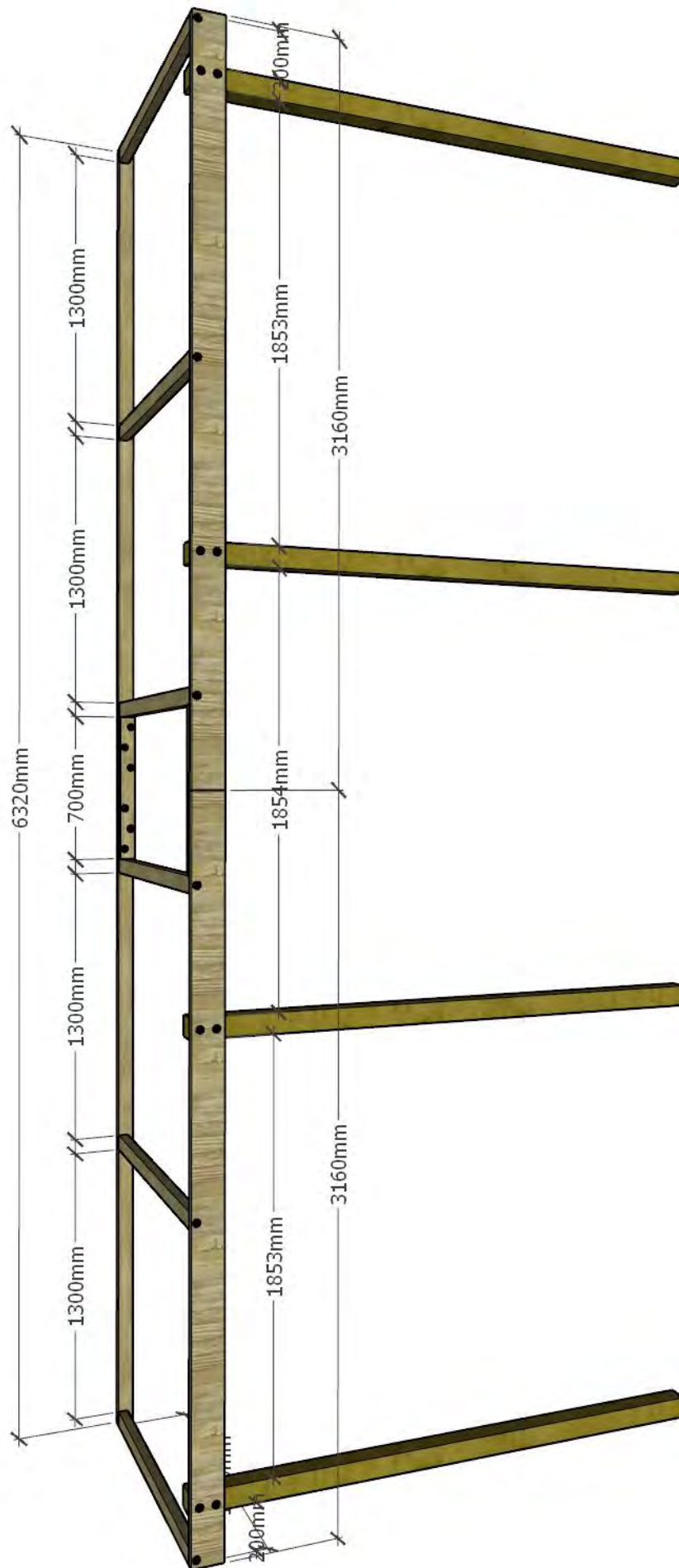

STEP 7.5

ANNEX ROOF INSTALATION

7.5 - ASSEMBLY PARTS – ANNEX ROOF INSTALLATION

PART CODE	QTY	DESCRIPTION
VP	4	Veranda Posts 2400x90x90mm
100BS	9	100mm batten screw
200PB	8	200mm M12 Post Bolt
W	16	M12 Washer

7.5 - ASSEMBLY – ANNEX ROOF INSTALLATION

- Using at least 3 people, butt the veranda roof hard up under shed roof as seen below. Support front of veranda roof while fastening through frame into shed wall studs, using 5x 100BS.
 - If installing on dirt*- dig holes and place posts in ground as seen in diagram on previous page (using concrete if you wish).
 - Once veranda frame is at desired height, screw through front beam into posts using 1x 100BS to hold posts in desired position** (**ENSURE THERE IS 30mm FALL DOWN FROM SHED TO FRONT OF VERANDA ROOF**).
 - Once posts are level in the desired position and veranda frame has **30mm of fall**, predrill holes (using a 13mm drill bit) and secure posts to VOB with 2x 200PB and 4x W.
- * If installing on concrete pad, use brackets and dyno bolt into place (fasteners not supplied).*
*** Fasten frame to posts once roughly the right height and then critique by hammering in or adding dirt (or concrete) till there is precisely **30mm fall from shed**.*

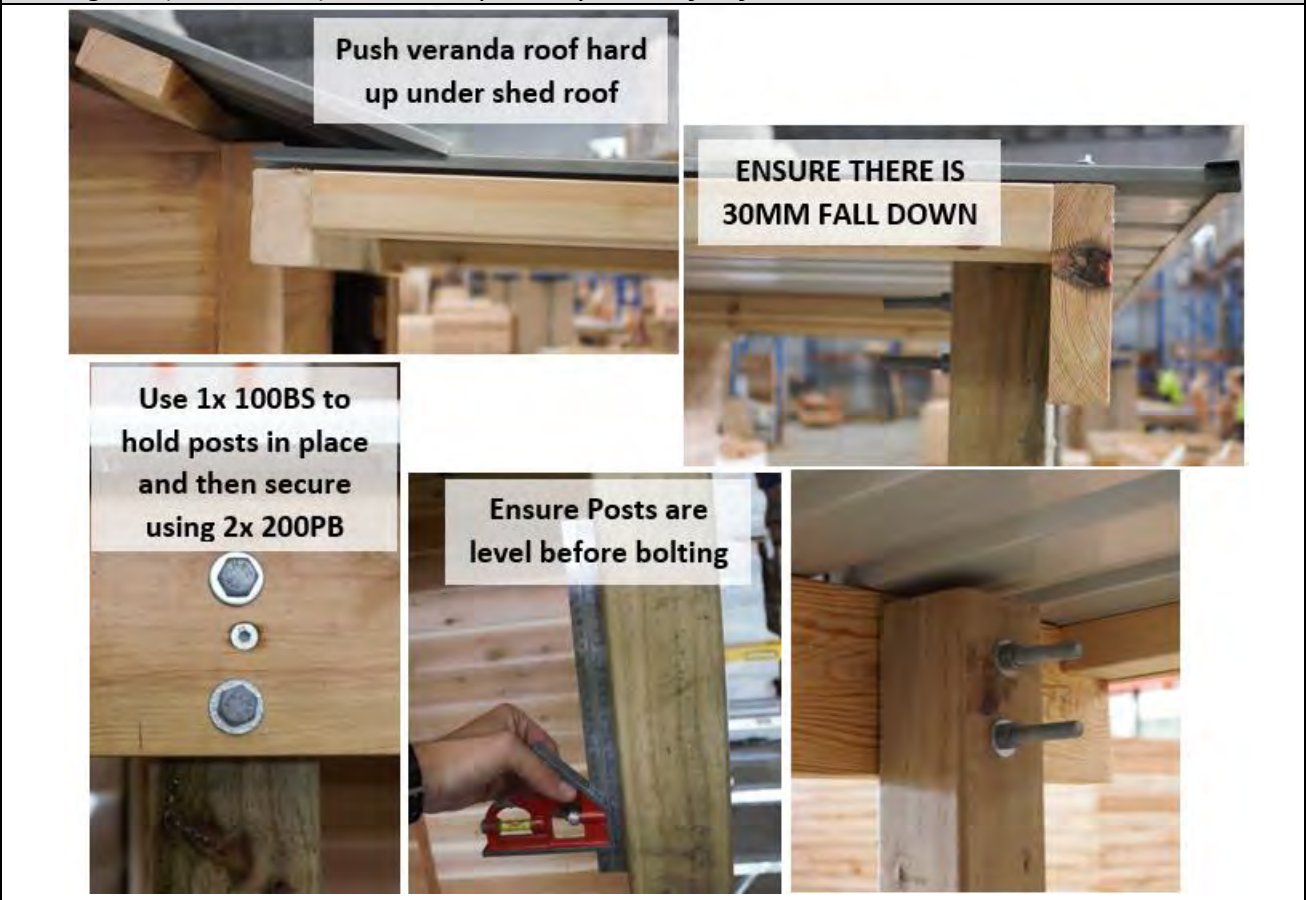

STEP 7.6

ANNEX FASCIA

7.6 - ASSEMBLY PARTS – ANNEX FASCIA

PART CODE	QTY	DESCRIPTION
VF	2	Veranda fascia 1350x140x20 block cedar
40N	8	40mm nail

7.6 - ASSEMBLY – ANNEX FASCIA

Once fascia's are on shed, trim annex fascia to butt in and finish correctly. Nail through fascia using 4 x 40N per fascia.



IMAGES TO HELP WITH INSTALLATION

FLOOR







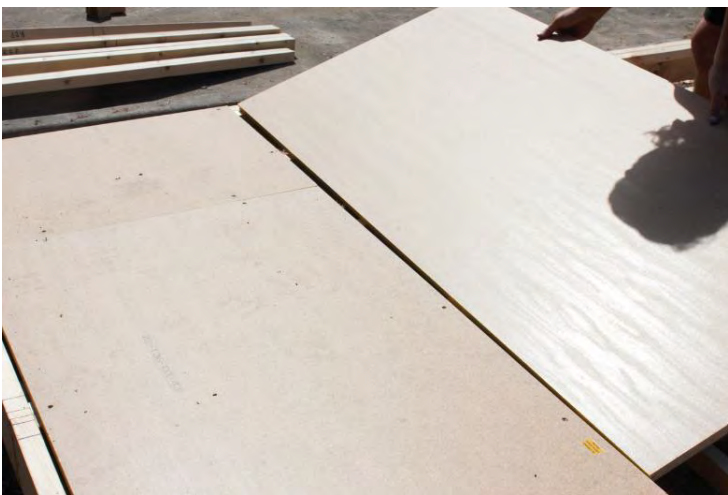







TO REGISTER YOUR WARRANTY

Thank-you for purchasing a STILLA product. To register your 10 year product warranty, please go to www.stilla.com.au/warranty and complete the online form. We recommend that you complete this step once you have finished installing your product.

PLEASE NOTE THAT IF YOU DO NOT COMPLETE THIS WARRANTY REGISTRATION FORM – YOUR PRODUCT IS NOT COVERED BY WARRANTY.

PRODUCT MAINTENANCE

We highly recommend you coat the external of your product with Intergrain UltraDeck Timber Stain – in the Colour Light Oak. This product is available from Dulux paint stores or Bunnings stores that have a paint section. The product is re tinted from a Cedar Cypress base to achieve the light oak colour – Intergrain is a Cabot's product (Having issues – Bring up Cabot's page on the paint desk computer and type Light Oak – this should bring up the formula)



24/10/2023

SHOW US YOUR SHED

We would love to see a photo of your STILLA product installed in your backyard. Please upload this image when completing the warranty registration. Alternatively, you can send the photos by email to sales@stilla.com.au.

If you require any assistance, please feel free to call or email.

Kind regards,

STILLA Customer Support

1800 784 552 | sales@stilla.com.au

